

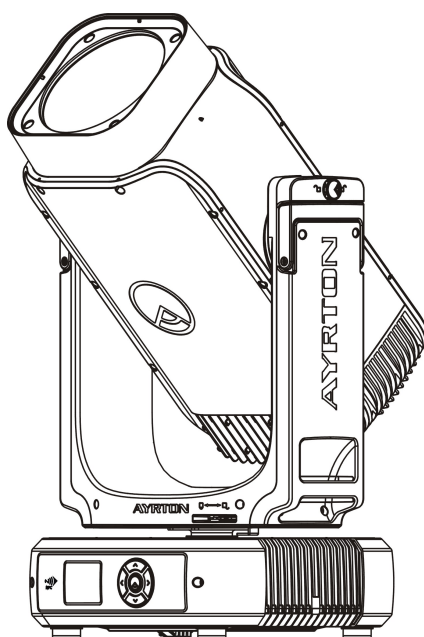

AYRTON
Digital Lighting



RIVALE
PROFILE

User Manual



SCAN FOR
SUPPORT

CONTENTS







1. SAFETY INSTRUCTIONS	1
2. FEATURES	3
3. FIXTURE OVERVIEW	4
4. DRAWINGS	4
5. INSTALLATION INSTRUCTIONS	8
6. DMX-512 CONTROL CONNECTION	10
7. DMX-512 CONNECTION WITH DMX TERMINATOR	10
8. DEVICE DMX START ADDRESS SELECTION	10
9. OPERATING INSTRUCTIONS OF THE INTERNAL DMX WIRELESS SYSTEM	11
10. DISPLAY	12
11. NFC	34
12. DMX PROTOCOL	38
13. ERROR MESSAGES	45
14. CLEANING AND MAINTENANCE	48

1. SAFETY INSTRUCTIONS

1.1 IMPORTANT SAFETY WARNINGS

This device has left the factory in perfect condition. In order to maintain this condition and to ensure safe operation, it is absolutely necessary for the user to follow the safety instructions and warning notes written in this user manual.

In order to install, operate and maintain the lighting fixture safely and correctly we suggest that the installation and operation be carried out by qualified technicians and these instructions be carefully followed.

	<p style="text-align: center;">CAUTION!</p> <p>HIGH VOLTAGE. RISK OF SEVERE OR FATAL ELECTRIC SHOCK.</p>
	<p style="text-align: center;">CAUTION!</p> <p>ALWAYS DISCONNECT MAINS SUPPLY BEFORE REMOVING ANY FIXTURE COVERS.</p>
	<p style="text-align: center;">CAUTION!</p> <p>NEVER LOOK DIRECTLY INTO THE LIGHT SOURCE. SENSITIVE PERSONS MAY SUFFER AN EPILEPTIC SHOCK.</p>
	<p style="text-align: center;">CAUTION!</p> <p>BLUE LIGHT HAZARD : RISK GROUP 2.</p>
	<p style="text-align: center;">CAUTION!</p> <p>NEVER TOUCH THE DEVICE DURING OPERATION. COVERS MAY BE HOT.</p>
	<p style="text-align: center;">CAUTION!</p> <p>THIS FIXTURE IS NOT DESIGNED FOR PERMANENT USE IN A MARINE / CORROSIVE ENVIRONMENT. FOLLOWING TEMPORARY USE IN SUCH ENVIRONMENTS, CLEAN FIXTURE WITH FRESH WATER AND DRY BEFORE STORAGE.</p>
	<p style="text-align: center;">CAUTION!</p> <p>WARNING: CHANGES OR MODIFICATIONS TO THIS UNIT NOT EXPRESSLY APPROVED BY THE PARTY RESPONSIBLE FOR COMPLIANCE COULD VOID THE USER'S AUTHORITY TO OPERATE THE EQUIPMENT.</p> <p>NOTE: THIS EQUIPMENT HAS BEEN TESTED AND FOUND TO COMPLY WITH THE LIMITS FOR A CLASS A DIGITAL DEVICE, PURSUANT TO PART 15 OF THE FCC RULES. THESE LIMITS ARE DESIGNED TO PROVIDE REASONABLE PROTECTION AGAINST HARMFUL INTERFERENCE WHEN THE EQUIPMENT IS OPERATED IN A COMMERCIAL ENVIRONMENT. THIS EQUIPMENT GENERATES, USES AND CAN RADIATE RADIO FREQUENCY ENERGY AND, IF NOT INSTALLED AND USED IN ACCORDANCE WITH THE INSTRUCTION MANUAL, MAY CAUSE HARMFUL INTERFERENCE TO RADIO COMMUNICATIONS. OPERATION OF THIS EQUIPMENT IN A RESIDENTIAL AREA IS LIKELY TO CAUSE HARMFUL INTERFERENCE IN WHICH CASE THE USER WILL BE REQUIRED TO CORRECT THE INTERFERENCE AT HIS OWN EXPENSE.</p>

IMPORTANT:

This fixture's external covers are made of magnesium alloy, care should be taken to avoid scratching the surface treatment of the covers. If it is accidentally scratched, need to repair the surface treatment and monitor regularly whether the repaired surface is corroded; if the corroded surface expands, need to replace the cover.

Damage caused by the disregard of this user manual is not subject to warranty. The dealer and

manufacturer will not accept liability for any resulting defects or problems.

- If the device has been exposed to temperature changes due to environmental conditions, do not power on immediately. The resulting condensation could damage the device. Leave the device powered off until it has reached room temperature.
- Ensure the sealing rubber covers of powerCON and XLR connectors are fitted properly when the device is not in use, to avoid water ingress.
- This device falls under protection-class I. Therefore, it is essential that the device be earthed.
- If either lenses or display are damaged (damage may include cracks or gashes in the material) they must be replaced.
- Electrical connections, such as replacing the power plug, must be performed by a qualified person.
- Make sure that the available voltage is not higher than that which is stated in this manual.
- Make sure the power cord is never crushed or damaged by sharp edges. If this should be the case, replacement of the cable must be done by an authorized dealer.
- If the external flexible power cord of this device is damaged, it shall be exclusively replaced by the manufacturer or their service agent or a similar qualified person in order to avoid injury.
- When the device is not in use or before performing maintenance, always disconnect the device from the mains. Only handle the power cord from the plug. Never pull the plug out of a socket by tugging the power cord.
- When powered on for the first time, some smoke or smell may occur. This is caused by coating on metal parts when heated and is normal. If you are concerned, please contact your distributor.
- Do not focus the beam onto flammable surfaces. The minimum distance between the exiting lens of the device and the illuminated surface must be greater than 3 meter.

Important: Please be aware that damage caused by any modifications to the device are not subject to warranty. Keep away from children and non-professionals.

1.2 GENERAL GUIDELINES

- This device is a lighting effect for professional use on stages, in discotheques, theatres, etc. the device was designed for indoor and outdoor use.
- This fixture is only allowed to be operated within the maximum alternating current as stated in the technical specifications in section 2 of this manual.
- Handle the device with care, avoid shaking or using force when installing or maintaining the device.
- If you use the quick lock cam when rigging the device, make sure the quick lock fasteners are located in the quick lock holes correctly and securely.
- Operate the device only after having familiarized yourself with its functions. Do not permit operation by persons not qualified for operating the device. Most damage is the result of unprofessional operation.
- Please use the original packaging if the device is to be transported.
- The applicable temperature for the device is between -20°C to 45°C. Do not use the device outside of this temperature range.
- The light source contained in this luminaire shall only be replaced by the manufacturer or his service agent or a similar qualified person.

Important: For safety reasons, please be aware that all modifications to the device are forbidden. If this device is operated in any way different to the ones described in this manual, the product may suffer damage and the warranty becomes void. Furthermore, any other operation may lead to short-circuits, burns, electric shocks etc.

2. FEATURES

POWER SUPPLY:

- AC100-240V~, 50/60Hz
- Power Consumption: 700W

LIGHT SOURCE:

- LED: White LED430W, 7400±400K Color Temperature @ S
White LED430W, 6500±300K Color Temperature @ TC
- Extremely long Life: >20,000H

MOVEMENT:

- Pan movement: Infinite rotation (16 bit)
- Tilt movement: Infinite rotation (16 bit)
- Advanced moving system: fast, stable and quite, auto X-Y repositioning

COLORS:

- CMY+CTO color mixing, uniform, linear and speed can be adjustable
- CTP, with linear and adjustable CRI
- 1 Color wheel: 7 dichroic filters + open, indexable

GOBOS:

- Rotating gobo wheel: 7 interchangeable, rotating and indexable gobo + open
- "Slot in & out" gobo wheel system
- Fix gobo wheel: 9 + open, with different speed gobo shaking and gobo indexing

FEATURES:

- 1 Control channel modes: 65 channels
- 2 Operation modes: DMX-512, Master / Slave mode
- Strobe effect with 1-25 flashes per second and pulse effect
- 2 Rotating Prisms: 5-facet circular and 4-facet linear
- 1 Animation effect: Black&White Animation, can make special dynamic effect
- Blades system
- Focus: Motorized focus
- Frost: 0%~100% linear change light frost and heavy frost
- Iris: 5%~100% linear change iris, pulse iris effect
- Dimmer: 0%~100% full range dimming

DISPLAY:

- Advanced and convenient full-color LCD
- Can be changed 180° reverse to fit for different installation position

SOFTWARE:

- Upgrades: fast and convenient through DMX cable with DMX-512 controller
- Reset DMX address, reset can all be done by the DMX controller
- Running time of fixture on display for reference

OTHER SPEC:

- Input signal isolation: guarantees stable signal transmission without interference
- Advanced RDM function

WEIGHT

- Net weight: 28 kg

3. FIXTURE OVERVIEW

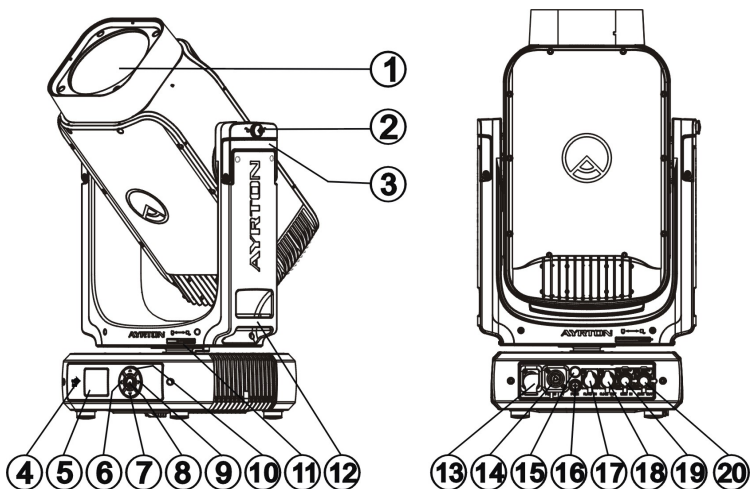

- 1) Front Lens
- 2) Tilt Lock
- 3) Handle
- 4) NFC
- 5) Display
- 6) Left-button
- 7) Down-button
- 8) Center-button
- 9) Right-button
- 10) Up-button
- 11) Pan Lock
- 12) Handle
- 13) Power In
- 14) Power Out
- 15) Valve
- 16) Fuse
- 17) RJ45 In
- 18) RJ45 Out
- 19) DMX In
- 20) DMX Out

4. DRAWINGS

4.1. Fixture Dimension

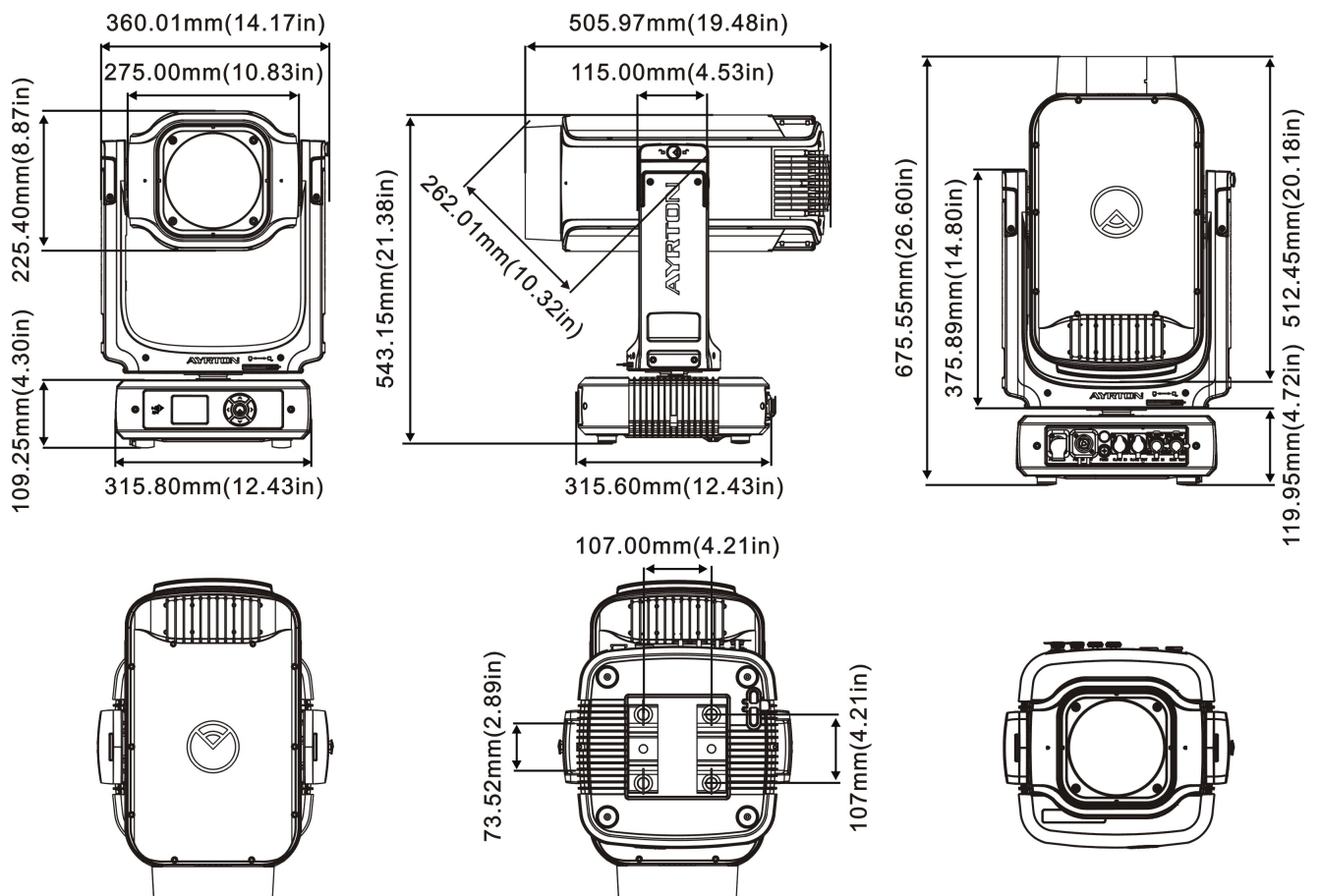

4.2. Color Wheel

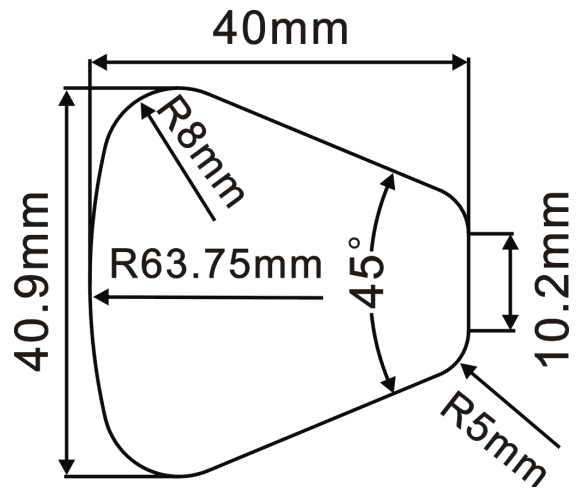

1. CTB1/4
(6.03.05.03.2892)
2. Magenta
(6.03.05.03.2893)
3. Congo Blue
(6.03.05.03.2894-0-02)
4. Green
(6.03.05.03.2895-0-02)
5. Orange
(6.03.05.03.2896-0-02)
6. Blue
(6.03.05.03.2897-0-02)
7. Red
(6.03.05.03.2898-0-02)

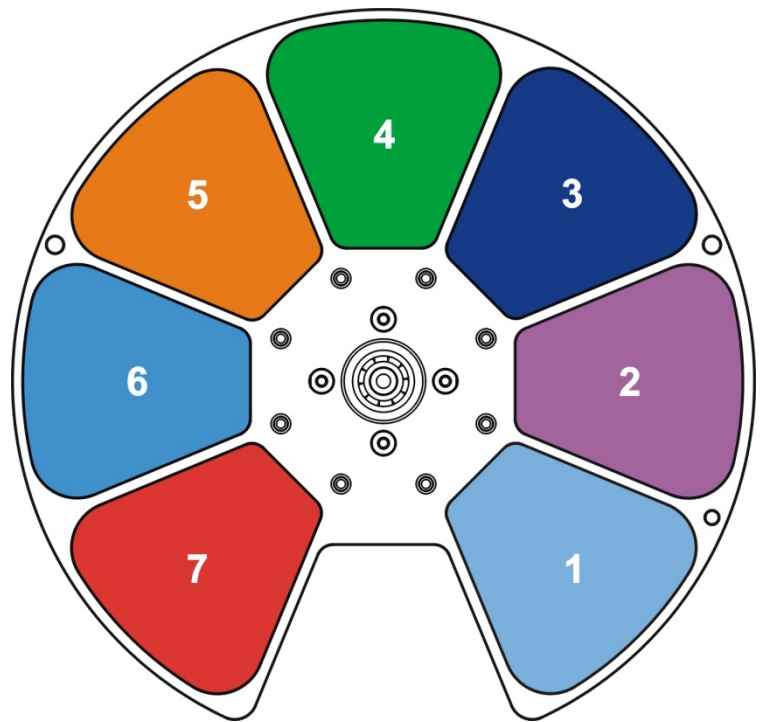

4.3. Rotating Gobo Wheel

Rotating Gobo:

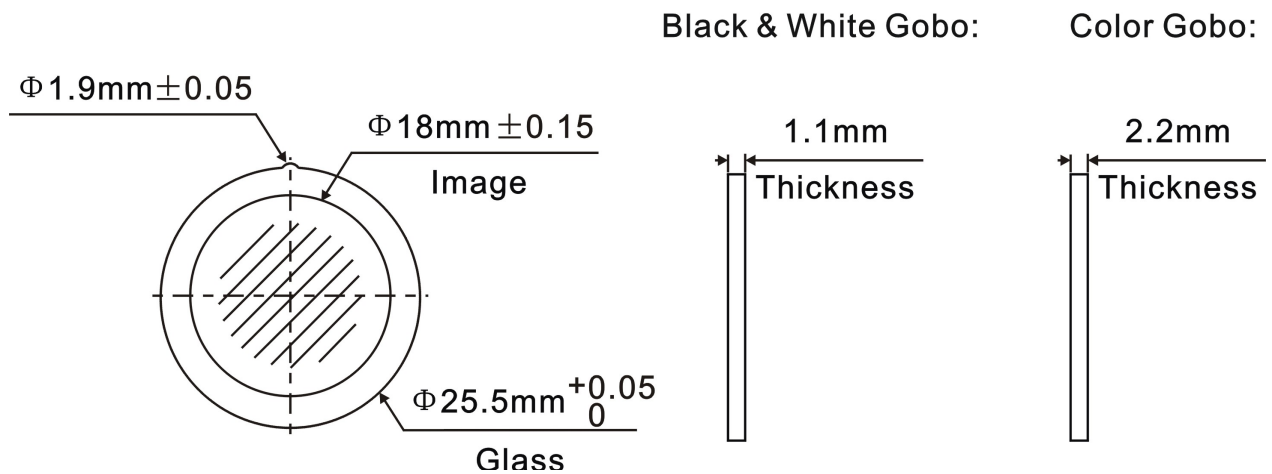

Rotating Gobo:

1. 130 – Dot Line 11
(6.03.03.01.2490)
2. 0745 – Star field
(6.03.03.01.2515)
3. 018 – Nested Triangle
(6.03.03.01.2492)
4. 039 – Infinite Stairs
(6.03.03.01.2496)
5. 278 – Bread Stix
(6.03.03.01.2514)
6. 070 – circle of square
(6.03.03.01.2516)
7. 112Y – Nested Rings Yellow
(6.03.03.01.2494)

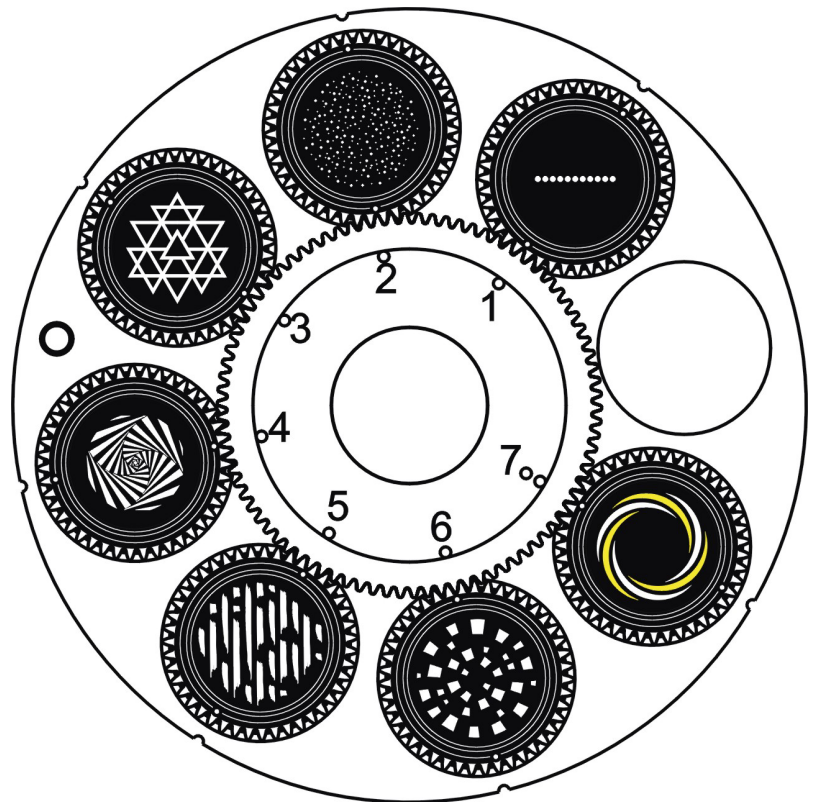

4.4. Fix Gobo Wheel

Fix Gobo:

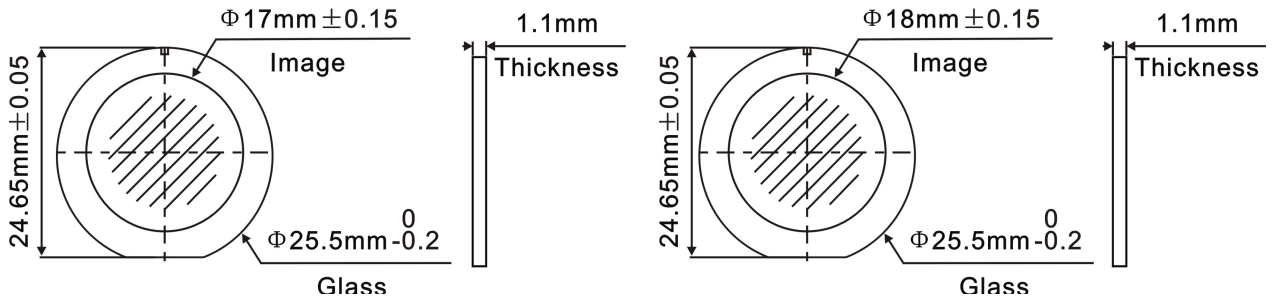

Fix Gobo:

1. 410 – Conical Tunnel Effect
(6.03.03.01.2346)
2. 049 – Smoke Rings
(6.03.03.01.2455)
3. 047 – Fireworks
(6.03.03.01.2456)
4. 066 – Abstract Square
(6.03.03.01.2457)
5. 081 – Iron Filings
(6.03.03.01.2458)
6. 041 – Lost In The Brain
(6.03.03.01.2459)
7. 101 – Deep Forest
(6.03.03.01.2460)
8. 105 – Tree Bark
(6.03.03.01.2461)
9. 190 – Mirror Ball
(6.03.03.01.2462)

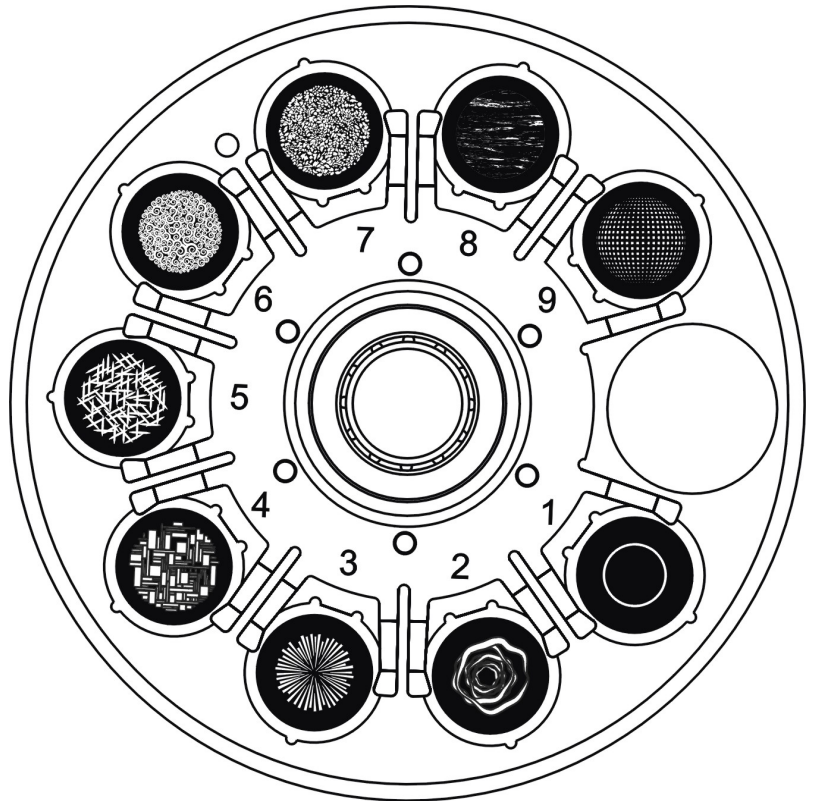

4.5.Animation Dimension

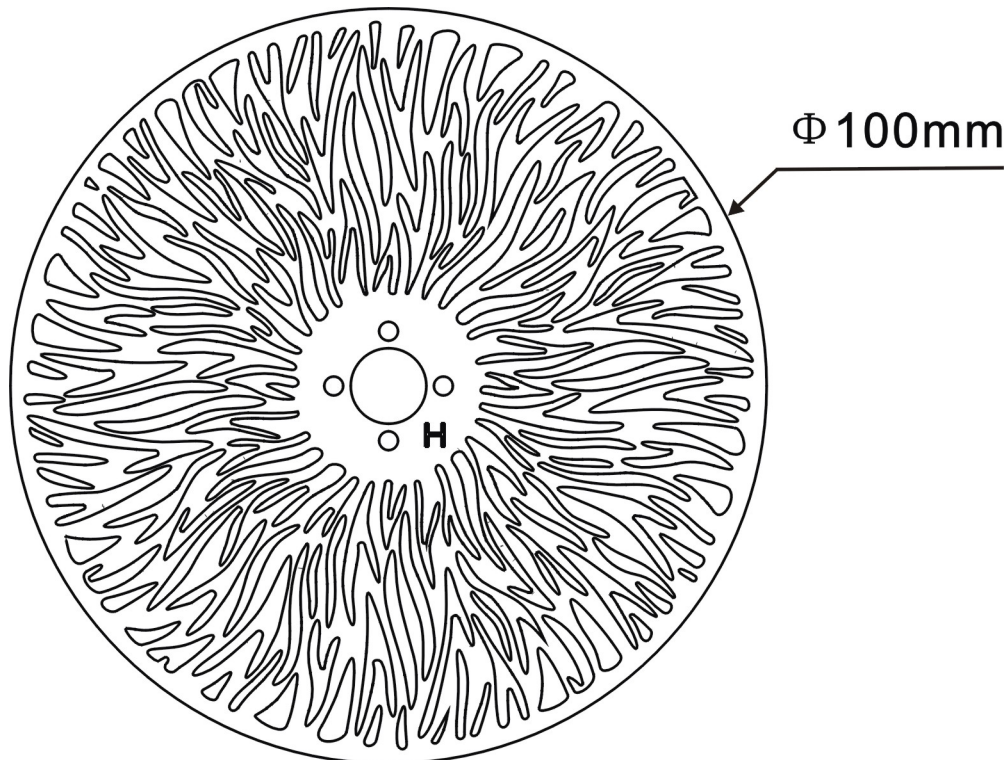

5. INSTALLATION INSTRUCTIONS

5.1.Rigging the device



CAUTION!

PLEASE CONSIDER THE RESPECTIVE NATIONAL NORMS DURING THE INSTALLATION. THE INSTALLATION MUST ONLY BE CARRIED OUT BY A QUALIFIED PERSON.

- The installation of the effect has to be built and constructed in a way that it can hold 10 times the weight for 1 hour without any harming deformation.
- The installation must always be secured with a secondary safety attachment, e.g. an appropriate safety rope.
- Never stand directly below the device when mounting, removing or servicing the fixture.
- The operator has to make sure the safety relating and machine technical installations are approved by an expert before taking the device into operation for the first time.
- These installations have to be approved by a skilled person once a year.
- Overhead mounting requires extensive experience, including amongst others calculating working load limits, installation material being used, and periodic safety inspection of all installation material and the device. If you lack these qualifications, do not attempt the installation yourself. Improper installation can result in bodily injury.

5.2.Rigging using the omega brackets

Important: This step is very important to ensure safe rigging of the fixture.

- Fix the clamp to the bracket by tightening the M12 nut and bolt to the bracket through the $\Phi 13$ hole in the middle of the bracket.
- Insert the quick-lock fasteners of the first Omega holder into the respective holes on the

bottom of the device. Tighten the quick-lock fasteners fully clockwise.

- Install the second Omega holder.
- Pull the safety cable through the holes on the bottom of the base and over the trussing system or another suitable rigging point. Insert the end into the carabiner and tighten the safety screw.

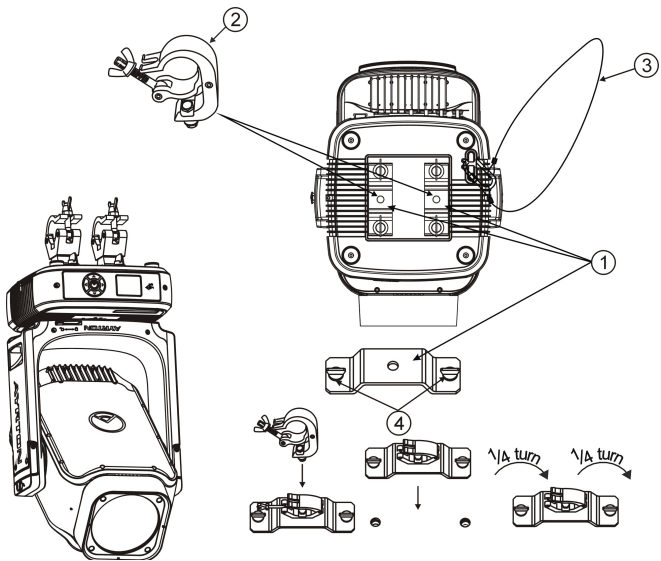

- 1) Omega bracket
- 2) Clamp
- 3) Safety rope
- 4) Quick-lock fastener

5.3. RIGGING DRAWINGS

Important:

Overhead rigging requires extensive experience, including (but not limited to) calculating working load limits, specifying installation/ rigging materials, and periodic safety inspection of all installation material as well as the device. If you lack these qualifications, do not attempt the rigging of this device yourself. Improper installation/ rigging can result in serious bodily injury.

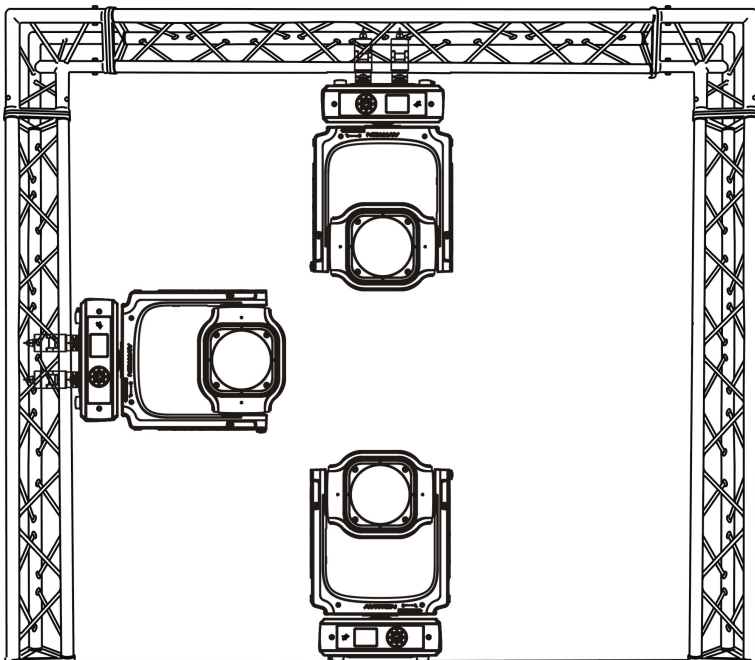

- Be sure this fixture is kept at least 0.1m away from any flammable materials (decoration etc.).
- Always use and install the supplied safety cable as a safety measure to prevent accidental damage and/or injury in the event the clamp fails.
- Rig the projector high enough to provide clearance for people who may walk beneath the beam path or establishing a restricted access area that extends beyond the beam hazard distance.

- Warnings! Please DO NOT let other external intense lights to shine through the fixture front lens, it may cause significant internal damages!
- When install fixture outdoor at day time (with power off), please make sure that the fixture front lens is NOT facing the sun.
- When use fixture outdoor at day time (with power on), please avoid fixture front lens facing

the sun.

- When fixture is on standby outdoor at day time (with power on), please make sure the "sun protection" mode is ON (default).

WARNING!

After installation in a corrosive environment, the external magnesium alloy covers surface shall not be in contact with other metal items (keep at least 5mm distance from other metal items).

This fixture is not designed for permanent use in a marine / corrosive environment.

Following temporary use in such environments, clean fixture with fresh water and dry before storage.

6. DMX-512 CONTROL CONNECTION

Connect the provided male side of the XLR cable to the female XLR output of your controller and the female side of the XLR cable to the male XLR input of the device. You can connect multiple devices together in a serial fashion. The cable needed should be two core, screened cable with XLR input and output connectors. Please refer to the diagram below.

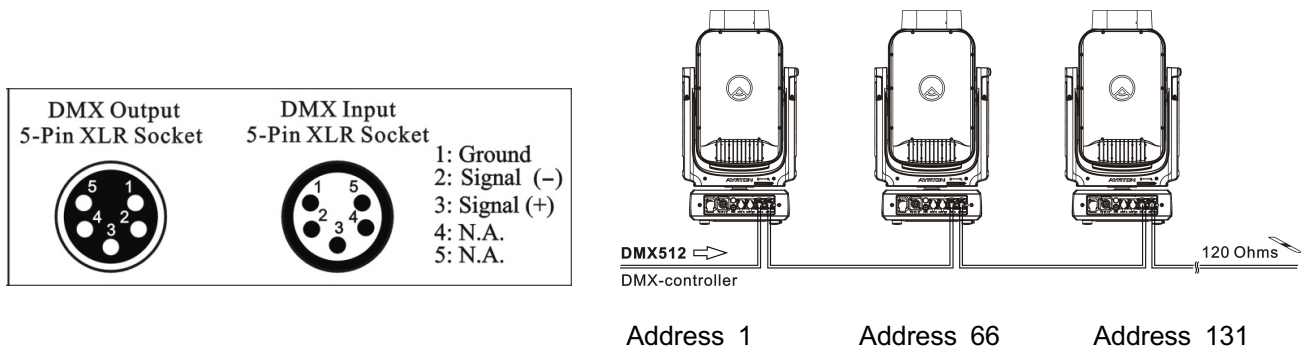

7. DMX-512 CONNECTION WITH DMX TERMINATOR

For installations where the DMX cable has to run over a long distance or is in an electrically noisy environment, such as in a discotheque, it is recommended to use a DMX terminator. This helps in preventing corruption of the digital control signal caused by electrical noise. The DMX terminator is an XLR plug with a 120 Ω resistor connected between pins 2 and 3, which is then plugged into the output (female) XLR socket of the last fixture in the chain. Please see illustrations below.

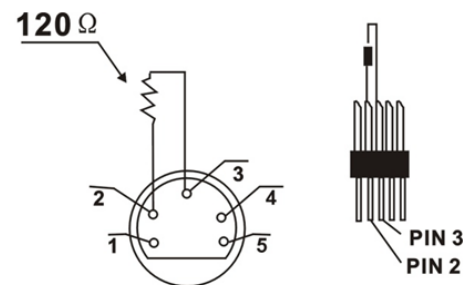

8. DEVICE DMX START ADDRESS SELECTION

All fixtures should be given a DMX starting address when using a DMX signal, so that the correct fixture responds to the correct control signals. This digital starting address is the channel number from which the fixture starts to "listen" to the digital control information sent out from the DMX controller. The allocation of this starting address is achieved by setting the correct address number on the display located on the base of the device.

You can set the same starting address for all fixtures or a group of fixtures, or set different addresses for each fixture individually.

If you set the same address on all devices, all the devices will start to "listen to" the same

control signal from the same channel number. In other words, changing the settings of one channel will affect all the fixtures simultaneously.

If you set a different address, each unit will start to “listen to” the channel number you have set, based on the quantity of control channels of the unit. That means changing the settings of one channel will affect only the selected device.

In the case of the LED moving head, in 65 channel mode, you should set the starting address of the first unit to 1, the second unit to 66 (65 + 1), the third unit to 131 (65+ 66), and so on.

9. OPERATING INSTRUCTIONS OF THE INTERNAL DMX WIRELESS SYSTEM

9.1 Equipments:

DMX 512 controller, wireless transmitter, and the fixtures with wireless receiver.

9.2 Message from the LED indicator:

- 1) Rapid flashing red/Green: logging in to a transmitter.
- 2) Slow flashing Red/Green: Logged on a transmitter and the DMX line is idle (No DMX is connected to transmitter).
- 3) Solid Green: Logged on to a transmitter and receiving DMX data.
- 4) Solid Red: Not logged on to a transmitter (free).

9.3 WDMX in the menu of the fixture:

On a fixture installed with wireless system, in order to switch between wireless control system and traditional DMX control (with cable), a new menu WDMX is added to the display board.

ON: (Activate WDMX)

- 1) When the fixture is on power, and the WDMX is activated to ON status, but did not connect to the controller and did not log in to the transmitter, the fixture will search for the DMX signal source. If the fixture is connected to the DMX controller it can be controlled by DMX controller; if it is log in to the wireless transmitter, it can be controlled by the Transmitter.
- 2) When the fixture is power off, and the WDMX is in ON status, if the fixture is connected to DMX controller. After the fixture is power on, it can be controlled only by the DMX controller which connected. The fixture can log in the wireless transmitter, and receive only radio signal from transmitter, but not DMX from the transmitter.

OFF: (De-activate WDMX)

In this status, wireless system is not activated, so the fixture can not log in the transmitter.

REST: (reset WDMX memory)

Can remove the fixture from the connection with the transmitter, the fixture become free and ready to log in any transmitter.

9.4 Setup the wireless system:

- 1) Connect the transmitter with the DMX controller.
- 2) To make the fixture installed with wireless receiver log in to the transmitter.
 - a) Initially, the indicator on the receiver fixture should be in Solid red.
 - b) Press and hold the configuration button on transmitter for less than 3 seconds the red/green LEDs on the transmitter and the receiver fixture will flash rapidly for about 5~

10 seconds while the system goes through its setup procedure.

- c) Once the receiver fixture is logged in to the transmitter (T1), the fixture with wireless receiver will keep the memory, even if restart the power, this unit will log in the transmitter (T1) automatically.
- 3) Use the DMX 512 to control the fixture

9.5 Remove the receivers from transmitter (T1) and to log in to another transmitter (T2):

Case 1: Remove a receiver:

- a) On the control board of the fixture, enter menu to activated the function of REST;
- b) The LED for wireless on the fixture should turn to Solid red; the receiver can log out from the transmitter (T1);
- c) press the configuration button on transmitter (T2) for less than 3 second, then the fixture will start to connect with the transmitter (T2).

Case 2: Remove all receivers from a transmitter (T1) to log in to T2:

- a) Press and hold the configuration button on the T1 as least 5 seconds, can clear the connection with all the fixtures;
- b) All the red/green LEDs on the receiver fixtures will turn to Solid red to indicate that the receivers are unassigned and removed from the transmitter (T1);
- c) Press and hold the configuration button on the T2 less then less than 3 second, the fixtures will connect with the T2.





PS:



1. Please log the receivers out from the transmitter after every job, so that the receivers are in free un assigned state and ready to be assigned to a transmitter.
2. Do not connect the fixture which is under the communication of wireless system to the DMX controller, otherwise it will cause interference from the DMX controller.

10. DISPLAY

The Display offers several features: you can set the starting address, run the pre-programmed program or reset the device.

The main menu is accessed by double clicking  -button until the display starts flashing.

Browse through the menu by pressing the  -button,  -button,  -button or  -button .

Press  for 2 seconds in order to exit menu, double click  for confirm. After accessing the edit mode, the unit will automatically exit to the main menu after 15 seconds from the last button press.

When the unit is powered on, if no data signal is connected after 1 minute, then the display will switch off automatically.

Default settings shaded

Address	Address	DMX Address: 001-XXX Decimal Universe: XXXXX Net: XX Sub-Net: X Universe: X	DMX Address Decimal Universe Net Sub-Net Universe	
Mode	User Mode	Extend Mode User Mode A User Mode B User Mode C	User's mode to change channel numbers	
	Edit User ModeA:	Max channel PAN :	Preset User modes A,B,C :	
Options	Status	No DMX Mode Sun Protection Pan Reverse Tilt Reverse Pan Degree Tilt Degree Feedback Encoder Select Init PAN Init TILT Prerig INIT Reset Mode Pan/Tilt Spd CMY Spd Zoom/Focus Spd Reset LED Fade Hibernation DMX Output	Close/Hold/Auto ON/OFF ON/OFF ON/OFF 630/540 270/540 ON/OFF Photoelectric/Magnet ON/OFF ON/OFF ON/OFF Fast/All Rot Gobos Medium/Fast/Slow Fast/Medium/Slow Fast/Medium/Slow ON/OFF OFF , 01M~99M ON/OFF	Auto run if no DMX Sun Protection Pan Reverse movement Tilt Reverse movement Pan Degree Select Tilt Degree Select Movement Feedback Encoder Select Init PAN Init TILT Prerig INIT Reset Mode Movement Speed CMY Spd Zoom/Focus Spd Reset LED Fade Stand by Mode DMX Output
	Service PIN	Service PIN Set Ip Set Mask IP Reset From Mac DHCP Cross Load SW Clr Error Info	Password=XXX xxx.xxx.xxx.xxx xxx.xxx.xxx.xxx ON/OFF ON/OFF ON/OFF ON/OFF	Service Password"=050" Set Ip Set Mask IP Reset From Mac DHCP Cross Load SW Clr LED Timer
	Fans Control	Fans Speed	Auto Stage Silence Super Silence	Fans Speed select
		Constant Fans	ON/OFF	Constant Fans
Disp.Setting	Shutoff Time Flip Display Key Lock DispFlash	02~60m 05m ON/OFF ON/OFF ON/OFF	Display shutoff time Reverse 180 degree Key Lock DispFlash	

	Signal Select	DMX WDMX Art-Net sACN	DMX WDMX Art-Net sACN
	Temp. C/F	Celsius Fahrenheit	Temperature switch between °C/°F
	Initial Pos.	PAN =XXX	Initial effect position
	Wireless DMX	Activate WDMX Rest WDMX	Activate WDMX Rest WDMX
	Dim Curve	Square Law Linear	
	Refresh Select	1.2K 2.4K 16K 25K	Refresh Select
	Defog	OFF Auto ON	Defog off Defog auto Defog on
	Gobo Correction	ON/OFF	Gobo Correction
	Reset P/T Fade	ON/OFF	Reset P/T Fade
	Frost (Progressive)	ON/OFF	Frost (Progressive)
	Trigger	DMX Value Disp. Set to Slave Auto Program	PAN..... Slave 1, Slave 2, Slave 3 Master/Alone
	ResetDefault	ON/OFF	DMX Value Disp. Set to Slave Auto Program
	Reset User	Address	DMX address:001-XXX Decimal Universe:XXXXX Net:XX Sub-Net:X Universe:X
		Mode	Extend Mode User Mode A User Mode B User Mode C
		Fans Speed	Auto Stage Silence Super Silence
		Constant Fans	ON/OFF
Info	Time Info.	Current Time Ttl Life Hrs Last Run Hrs LED Hours Timer PIN Clr Last Run	XXXX(Hours) XXXX(Hours) XXXX(Hours) XXXX(Hours) Password=XXX ON/OFF

	Temp. Info	Head Temp.	XXX°C/°F
	Humidity	x%	Humidity
	Encoder Info	xxx	Encoder Info
	Fan Info.	xxxx RPM	Fan information
	LED Type	xxx	LED Type
	Software Ver	V1.0.....	Software version
	RTC	xxx	System time
	Signal Quality	xxx	Signal Quality Information
	Network	IP,Mask,Mac	Network
	Error Info.	Error Record 1 :	Error Info.
	SN	xxxxxx	SN
Test	Home	All Pan&Tilt Color Gobo Other	All Pan&Tilt Color Gobo Othe
	Test Channel	PAN	Test function
	Manual Ctrl.	PAN =XXX :	Fine adjustment of the lamp
	Calibration	-Password- PAN :	Password "050" Calbrate and adjust the effects to standard/right position
	Magn Auto Cal	-Password- Calibration	Magn Auto Cal
	Magn P/T 50%	-Password- PAN TILT Calibration	Magn P/T 50%
Gobo Replace	Gobo Wheel 1 Gobo Wheel 2	Gobo Replace	
Preset	Select Prog.	Prog. Part 1 = Program 1 ~ 10 Prog. Part 2 = Program 1 ~ 10 Prog. Part 3 = Program 1 ~ 10	Program 1 Program 2 Program 3 Select programs to be run
	Edit Prog.	Program 1 : Program 10	Program Test Step 01=SCxxx Step 64=SCxxx Testing program Program in loop Save and exit
	Edit Scenes	Edit Scene 001 ~ Edit Scene 250	Pan,Tilt,..... --Fade Time-- --Secne Time-- Input By Outside Save and automatically return manual scenes edit
	Scenes Input	XX~XX	Scenes Input

10.1 Address

10.1.1. Address

With this function, you can adjust the desired DMX-address via the Display.

1. Double clicking center button to access main menu.
2. Tap the <Up/Down> button until "Address" is displayed.
3. Double clicking center button to access "Address", Tap the <Up/Down> button to select "Main".
4. Double clicking center button to access "Address" menu, The display will show "DMX Address: 001-XXX"、"Decimal Universe: XXXXX"、"Net: XX"、"Sub-Net: X"、"Universe: X".
5. Double click the center button to confirm or long press the center button to return to the main menu.

10.2 Mode

10.2.1. User Mode

With this function, you can create user defined channel orders.

1. Double clicking center button to access main menu; Tap the <Up/Down> button until "Mode" is displayed. Double clicking center button to enter.
2. Press <Up/Down>, the display will show "User Mode".
3. Double clicking center button to enter.
4. When in "Extend Mode", Press <Up/Down> button to select "Extend Mode", "User Mode A", "User Mode B" and "User Mode C".
5. Double click the center button to confirm or long press the center button to return to the main menu.

10.2.2. Edit User Mode

With this function, you can adjust the rest user defined channel order.

1. Double clicking center button to access main menu; Tap the <Up/Down> button until "Mode" is displayed. Double clicking center button to enter.
2. Press <Up/Down>, the display will show "Edit User Mode".
3. Double clicking center button to enter.
4. Set up "Max Channel=xxx" and select channel value.
5. Set up "Mode B" and "Mode C" by the same way.
6. Double click the center button to confirm or long press the center button to return to the main menu.

10.3 Options

10.3.1. Status

No DMX Status

With this function, when the drive is not DMX signal, it runs automatism, close, hold and music, the default is hold.

1. Double clicking center button to access main menu.
2. Tap the <Up/Down> button until "Options" is displayed.
3. Double clicking center button to access "Options", Tap the <Up/Down> button to select "Status".
4. Double clicking center button to access "Status" menu, Tap the <Up/Down> button to select "No DMX Status".
5. Double clicking center button to access "No DMX Status", The display will show "Hold", Tap the <Up/Down> button to select "Close", "Auto".
6. Double click the center button to confirm or long press the center button to return to the main menu.

Sun Protection

1. Double clicking center button to access main menu.
2. Tap the <Up/Down> button until "Options" is displayed.
3. Double clicking center button to access "Options", Tap the <Up/Down> button to select "Status".
4. Double clicking center button to access "Status" menu, Tap the <Up/Down> button to select "Sun Protection".
5. Double clicking center button to access "Sun Protection", The display will show "ON", Tap the <Up/Down> button to select "OFF".
6. Double click the center button to confirm or long press the center button to return to the main menu.

Pan Reverse

With this function you can reverse the Pan-movement.

1. Double clicking center button to access main menu.
2. Tap the <Up/Down> button until "Options" is displayed.
3. Double clicking center button to access "Options", Tap the <Up/Down> button to select "Status".
4. Double clicking center button to access "Status" menu, Tap the <Up/Down> button to select "Pan Reverse".
5. Double clicking center button to access "Pan Reverse", The display will show "OFF", Tap the <Up/Down> button to select "ON".
6. Double click the center button to confirm or long press the center button to return to the main menu.

Tilt Reverse

With this function you can reverse the Tilt-movement.

1. Double clicking center button to access main menu.
2. Tap the <Up/Down> button until "Options" is displayed.
3. Double clicking center button to access "Options", Tap the <Up/Down> button to select "Status".
4. Double clicking center button to access "Status" menu, Tap the <Up/Down> button to select "Tilt Reverse".
5. Double clicking center button to access "Tilt Reverse", The display will show "OFF", Tap the <Up/Down> button to select "ON".
6. Double click the center button to confirm or long press the center button to return to the main menu.

Pan Degree

With this function, you can select pan degree for 630 or 540.

1. Double clicking center button to access main menu.
2. Tap the <Up/Down> button until "Options" is displayed.
3. Double clicking center button to access "Options", Tap the <Up/Down> button to select "Status".
4. Double clicking center button to access "Status" menu, Tap the <Up/Down> button to select "Pan Degree".
5. Double clicking center button to access "Pan Degree", The display will show "540", Tap the <Up/Down> button to select "630".
6. Double click the center button to confirm or long press the center button to return to the main menu.

Tilt Degree

With this function, you can select tilt degree for 270 or 540.

1. Double clicking center button to access main menu.
2. Tap the <Up/Down> button until "Options" is displayed.
3. Double clicking center button to access "Options", Tap the <Up/Down> button to select "Status".
4. Double clicking center button to access "Status" menu, Tap the <Up/Down> button to select "Tilt Degree".
5. Double clicking center button to access "Tilt Degree", The display will show "270", Tap the <Up/Down> button to select "540".
6. Double click the center button to confirm or long press the center button to return to the main menu.

Feedback

With this function, you can feedback switch of pan movement or tilt movement.

1. Double clicking center button to access main menu.
2. Tap the <Up/Down> button until "Options" is displayed.
3. Double clicking center button to access "Options", Tap the <Up/Down> button to select "Status".
4. Double clicking center button to access "Status" menu, Tap the <Up/Down> button to select "Feedback".
5. Double clicking center button to access "Feedback", The display will show "ON", Tap the <Up/Down> button to select "OFF".
6. Double click the center button to confirm or long press the center button to return to the main menu.

Encoder Select

1. Double clicking center button to access main menu.
2. Tap the <Up/Down> button until "Options" is displayed.
3. Double clicking center button to access "Options", Tap the <Up/Down> button to select "Status".
4. Double clicking center button to access "Status" menu, Tap the <Up/Down> button to select "Encoder Select".
5. Double clicking center button to access "Encoder Select", The display will show "Magnet", Tap the <Up/Down> button to select "Photoelectric".
6. Double click the center button to confirm or long press the center button to return to the main menu.

Init PAN

With this function, you can feedback switch of pan movement or tilt movement.

1. Double clicking center button to access main menu.
2. Tap the <Up/Down> button until "Options" is displayed.
3. Double clicking center button to access "Options", Tap the <Up/Down> button to select "Status".
4. Double clicking center button to access "Status" menu, Tap the <Up/Down> button to select "Init PAN".
5. Double clicking center button to access "Init PAN", The display will show "ON", Tap the <Up/Down> button to select "OFF".
6. Double click the center button to confirm or long press the center button to return to the main menu.

Init TILT

With this function, you can feedback switch of pan movement or tilt movement.

1. Double clicking center button to access main menu.

2. Tap the <Up/Down> button until “Options” is displayed.
3. Double clicking center button to access “Options”, Tap the <Up/Down> button to select “Status”.
4. Double clicking center button to access “Status” menu, Tap the <Up/Down> button to select “Init TILT”.
5. Double clicking center button to access “Init TILT”, The display will show “ON”, Tap the <Up/Down> button to select “OFF”.
6. Double click the center button to confirm or long press the center button to return to the main menu.

Prerig INIT

1. Double clicking center button to access main menu.
2. Tap the <Up/Down> button until “Options” is displayed.
3. Double clicking center button to access “Options”, Tap the <Up/Down> button to select “Status”.
4. Double clicking center button to access “Status” menu, Tap the <Up/Down> button to select “Prerig INIT”.
5. Double clicking center button to access “Prerig INIT”, The display will show “OFF”, Tap the <Up/Down> button to select “ON”.
6. Double click the center button to confirm or long press the center button to return to the main menu.

Reset Mode

1. Double clicking center button to access main menu.
2. Tap the <Up/Down> button until “Options” is displayed.
3. Double clicking center button to access “Options”, Tap the <Up/Down> button to select “Status”.
4. Double clicking center button to access “Status” menu, Tap the <Up/Down> button to select “Reset Mode”.
5. Double clicking center button to access “Reset Mode”, The display will show “Fast”, Tap the <Up/Down> button to select “All Rot Gobos”.
6. Double click the center button to confirm or long press the center button to return to the main menu.

Pan/Tilt Spd

With this function, you can select scan mode from “Fast”, “Medium”, “Slow”.

1. Double clicking center button to access main menu.
2. Tap the <Up/Down> button until “Options” is displayed.
3. Double clicking center button to access “Options”, Tap the <Up/Down> button to select “Status”.
4. Double clicking center button to access “Status” menu, Tap the <Up/Down> button to select “Pan/Tilt Spd”.
5. Double clicking center button to access “Pan/Tilt Spd”, The display will show “Medium”, Tap the <Up/Down> button to select “Fast”, “Medium”, “Slow”.
6. Double click the center button to confirm or long press the center button to return to the main menu.

CMY Spd

1. Double clicking center button to access main menu.
2. Tap the <Up/Down> button until “Options” is displayed.
3. Double clicking center button to access “Options”, Tap the <Up/Down> button to select “Status”.
4. Double clicking center button to access “Status” menu, Tap the <Up/Down> button to

select “CMY Spd”.

5. Double clicking center button to access “CMY Spd”, The display will show “Fast”, Tap the <Up/Down> button to select “Fast”, “Medium”, “Slow”.
6. Double click the center button to confirm or long press the center button to return to the main menu.

Zoom/Focus Spd

1. Double clicking center button to access main menu.
2. Tap the <Up/Down> button until “Options” is displayed.
3. Double clicking center button to access “Options”, Tap the <Up/Down> button to select “Status”.
4. Double clicking center button to access “Status” menu, Tap the <Up/Down> button to select “Zoom/Focus Spd”.
5. Double clicking center button to access “Zoom/Focus Spd”, The display will show “Fast”, Tap the <Up/Down> button to select “Fast”, “Medium”, “Slow”.
6. Double click the center button to confirm or long press the center button to return to the main menu.

Reset LED Fade

1. Double clicking center button to access main menu.
2. Tap the <Up/Down> button until “Options” is displayed.
3. Double clicking center button to access “Options”, Tap the <Up/Down> button to select “Status”.
4. Double clicking center button to access “Status” menu, Tap the <Up/Down> button to select “Reset LED Fade”.
5. Double clicking center button to access “Reset LED Fade”, The display will show “OFF”, Tap the <Up/Down> button to select “ON”.
6. Double click the center button to confirm or long press the center button to return to the main menu.

Hibernation

The device and step motors will be power off if the fixture stay without DMX signal for 15 mins (Factory default).And the fixture will be reset before working once it receive DMX signal again.

1. Double clicking center button to access main menu.
2. Tap the <Up/Down> button until “Options” is displayed.
3. Double clicking center button to access “Options”, Tap the <Up/Down> button to select “Status”.
4. Double clicking center button to access “Status” menu, Tap the <Up/Down> button to select “Hibernation”.
5. Double clicking center button to access “Hibernation”, The display will show “OFF”, Tap the <Up/Down> button to select “01M”, “02M” . . . “99M”.
6. Double click the center button to confirm or long press the center button to return to the main menu.

DMX Output

1. Double clicking center button to access main menu.
2. Tap the <Up/Down> button until “Options” is displayed.
3. Double clicking center button to access “Options”, Tap the <Up/Down> button to select “Status”.
4. Double clicking center button to access “Status” menu, Tap the <Up/Down> button to select “DMX Output”.
5. Double clicking center button to access “DMX Output”, The display will show “OFF”,

Tap the <Up/Down> button to select “ON”.

6. Double click the center button to confirm or long press the center button to return to the main menu.

10.3.2. Service PIN

Password

The Password for this function is “050”.

Set IP

1. Double clicking center button to access main menu.
2. Tap the <Up/Down> button until “Options” is displayed.
3. Double clicking center button to access “Options”, Tap the <Up/Down> button to select “Service PIN”.
4. Double clicking center button to access “Service PIN” menu, Tap the <Up/Down> button to select “Set IP”.
5. Double clicking center button to access “Set IP”, The display will show “XXX.XXX.XXX.XXX”.
6. Double click the center button to confirm or long press the center button to return to the main menu.

Set Mask IP

1. Double clicking center button to access main menu.
2. Tap the <Up/Down> button until “Options” is displayed.
3. Double clicking center button to access “Options”, Tap the <Up/Down> button to select “Service PIN”.
4. Double clicking center button to access “Service PIN” menu, Tap the <Up/Down> button to select “Set Mask IP”.
5. Double clicking center button to access “Set Mask IP”, The display will show “XXX.XXX.XXX.XXX”.
6. Double click the center button to confirm or long press the center button to return to the main menu.

Reset From Mac

1. Double clicking center button to access main menu.
2. Tap the <Up/Down> button until “Options” is displayed.
3. Double clicking center button to access “Options”, Tap the <Up/Down> button to select “Service PIN”.
4. Double clicking center button to access “Service PIN” menu, Tap the <Up/Down> button to select “Reset From Mac”.
5. Double clicking center button to access “Reset From Mac”, The display will show “OFF”, Tap the <Up/Down> button to select “ON”.
6. Double click the center button to confirm or long press the center button to return to the main menu.

DHCP

1. Double clicking center button to access main menu.
2. Tap the <Up/Down> button until “Options” is displayed.
3. Double clicking center button to access “Options”, Tap the <Up/Down> button to select “Service PIN”.
4. Double clicking center button to access “Service PIN” menu, Tap the <Up/Down> button to select “DHCP”.
5. Double clicking center button to access “DHCP”, The display will show “OFF”, Tap the <Up/Down> button to select “ON”.

6. Double click the center button to confirm or long press the center button to return to the main menu.

Cross Load SW

1. Double clicking center button to access main menu.
2. Tap the <Up/Down> button until “Options” is displayed.
3. Double clicking center button to access “Options”, Tap the <Up/Down> button to select “Service PIN”.
4. Double clicking center button to access “Service PIN” menu, Tap the <Up/Down> button to select “Cross Load SW”.
5. Double clicking center button to access “Cross Load SW”, The display will show “OFF”, Tap the <Up/Down> button to select “ON”.
6. Double click the center button to confirm or long press the center button to return to the main menu.

Clr Error Info

1. Double clicking center button to access main menu.
2. Tap the <Up/Down> button until “Options” is displayed.
3. Double clicking center button to access “Options”, Tap the <Up/Down> button to select “Service PIN”.
4. Double clicking center button to access “Service PIN” menu, Tap the <Up/Down> button to select “Clr Error Info”.
5. Double clicking center button to access “Clr Error Info”, The display will show “OFF”, Tap the <Up/Down> button to select “ON”.
6. Double click the center button to confirm or long press the center button to return to the main menu.

10.3.3. Fans Control

Fans Speed

With this function you can set the speed of the running fans. The selections have Auto、Stage、Silence and Super Silence.

1. Double clicking center button to access main menu.
2. Tap the <Up/Down> button until “Options” is displayed.
3. Double clicking center button to access “Options”, Tap the <Up/Down> button to select “Fans Control”.
4. Double clicking center button to access “Fans Control” menu, Tap the <Up/Down> button to select “Fans Speed”.
5. Double clicking center button to access “Fans Speed I”, The display will show “Auto”, Tap the <Up/Down> button to select “Stage”, “Silence”, “Super Silence”.
6. Double click the center button to confirm or long press the center button to return to the main menu.

Constant Fans

1. Double clicking center button to access main menu.
2. Tap the <Up/Down> button until “Options” is displayed.
3. Double clicking center button to access “Options”, Tap the <Up/Down> button to select “Fans Control”.
4. Double clicking center button to access “Fans Control” menu, Tap the <Up/Down> button to select “Constant Fans”.
5. Double clicking center button to access “Constant Fans”, The display will show “OFF”, Tap the <Up/Down> button to select “ON”.
6. Double click the center button to confirm or long press the center button to return to the main menu.

10.3.4. Disp. Setting

Shut off Time

With this function you can shut off the LCD display after 2 to 60 minutes. The default is 5 minutes.

1. Double clicking center button to access main menu.
2. Tap the <Up/Down> button until "Options" is displayed.
3. Double clicking center button to access "Options", Tap the <Up/Down> button to select "Display Setting".
4. Double clicking center button to access "Display Setting" menu, Tap the <Up/Down> button to select "Shut off Time".
5. Double clicking center button to access "Shut off Time", The display will show "05m", Tap the <Up/Down> button to select "02~60m".
6. Double click the center button to confirm or long press the center button to return to the main menu.

Flip Display

With this function you can rotate the display by 180°.

1. Double clicking center button to access main menu.
2. Tap the <Up/Down> button until "Options" is displayed.
3. Double clicking center button to access "Options", Tap the <Up/Down> button to select "Display Setting".
4. Double clicking center button to access "Display Setting" menu, Tap the <Up/Down> button to select "Flip Display".
5. Double clicking center button to access "Flip Display", The display will show "OFF", Tap the <Up/Down> button to select "ON".
6. Double click the center button to confirm or long press the center button to return to the main menu.

Key Lock

With this function you can activate the automatic key lock function. If this function is activated, the keys will be locked automatically after exiting the edit mode for 15 seconds. Keeping press the <MODE/ESC> key for 3 seconds if you do not need this function.

1. Double clicking center button to access main menu.
2. Tap the <Up/Down> button until "Options" is displayed.
3. Double clicking center button to access "Options", Tap the <Up/Down> button to select "Display Setting".
4. Double clicking center button to access "Display Setting" menu, Tap the <Up/Down> button to select "Key Lock".
5. Double clicking center button to access "Key Lock", The display will show "OFF", Tap the <Up/Down> button to select "ON".
6. Double click the center button to confirm or long press the center button to return to the main menu.

DispFlash

With this function you can the entire display to be flipped by 180° to allow for better view when the fixture is hung from truss or a ceiling. This function is disabled as default.

1. Double clicking center button to access main menu.
2. Tap the <Up/Down> button until "Options" is displayed.
3. Double clicking center button to access "Options", Tap the <Up/Down> button to select "Display Setting".
4. Double clicking center button to access "Display Setting" menu, Tap the <Up/Down> button to select "DispFlash".

5. Double clicking center button to access “DispFlash”, The display will show “OFF”, Tap the <Up/Down> button to select “ON”.
6. Double click the center button to confirm or long press the center button to return to the main menu.

10.3.5. Signal Select

1. Double clicking center button to access main menu.
2. Tap the <Up/Down> button until “Options” is displayed.
3. Double clicking center button to access “Options”, Tap the <Up/Down> button to select “Signal Select”.
4. Double clicking center button to access “Signal Select”, The display will show “DMX”, Tap the <Up/Down> button to select “DMX”, “WDMX”, “Art-Net”, “sACN”.
5. Double click the center button to confirm or long press the center button to return to the main menu.

10.3.6. Temperature C/F

With this function you can display the temperature in Celsius or Fahrenheit.

1. Double clicking center button to access main menu.
2. Tap the <Up/Down> button until “Options” is displayed.
3. Double clicking center button to access “Options”, Tap the <Up/Down> button to select “Temperature C/ F”.
4. Double clicking center button to access “Temperature C/ F”, The display will show “Fahrenheit”, Tap the <Up/Down> button to select “Celsius”.
5. Double click the center button to confirm or long press the center button to return to the main menu.

10.3.7. Initial Pos.

With this function you can display initial effect position.

1. Double clicking center button to access main menu.
2. Tap the <Up/Down> button until “Options” is displayed.
3. Double clicking center button to access “Options”, Tap the <Up/Down> button to select “Initial Pos.”.
4. Double clicking center button to access “Initial Pos.”, The display will show “PAN=XXX”.
5. Double click the center button to confirm or long press the center button to return to the main menu.

10.3.8. Wireless

From factory, this projector is prepared for wireless data transmission (W-DMX) .If you wish to de-activate W-DMX control, you can select the function “De-activate WDMX” by turning the encoder. With the function “rest”, you can log out the projector from the wireless sender.

1. Double clicking center button to access main menu.
2. Tap the <Up/Down> button until “Options” is displayed.
3. Double clicking center button to access “Options”, Tap the <Up/Down> button to select “Wireless”.
4. Double clicking center button to access “Wireless”, The display will show “Activate WDMX”, Tap the <Up/Down> button to select “Rest WDMX”.
5. Double click the center button to confirm or long press the center button to return to the main menu.

10.3.9. Dim Curve

1. Double clicking center button to access main menu.
2. Tap the <Up/Down> button until “Options” is displayed.

3. Double clicking center button to access “Options”, Tap the <Up/Down> button to select “Dim Curve”.
4. Double clicking center button to access “Dim Curve”, The display will show “Square Law”, Tap the <Up/Down> button to select “Linear”.
5. Double click the center button to confirm or long press the center button to return to the main menu.

10.3.10. Refresh Select

With this function you can select the refresh.

1. Double clicking center button to access main menu.
2. Tap the <Up/Down> button until “Options” is displayed.
3. Double clicking center button to access “Options”, Tap the <Up/Down> button to select “Refresh Select”.
4. Double clicking center button to access “Refresh Select”, The display will show “1.2K”, Tap the <Up/Down> button to select “2.4K”, “16K”, “25K”.
5. Double click the center button to confirm or long press the center button to return to the main menu.

10.3.11. Defog

1. Double clicking center button to access main menu.
2. Tap the <Up/Down> button until “Options” is displayed.
3. Double clicking center button to access “Options”, Tap the <Up/Down> button to select “Defog”.
4. Double clicking center button to access “Defog”, The display will show “Auto”, Tap the <Up/Down> button to select “OFF”, “Auto”, “ON”.
5. Double click the center button to confirm or long press the center button to return to the main menu.

10.3.12. Gobo Correction

1. Double clicking center button to access main menu.
2. Tap the <Up/Down> button until “Options” is displayed.
3. Double clicking center button to access “Options”, Tap the <Up/Down> button to select “Gobo Correction”.
4. Double clicking center button to access “Gobo Correction”, The display will show “ON”, Tap the <Up/Down> button to select “OFF”.
5. Double click the center button to confirm or long press the center button to return to the main menu.

10.3.13. Reset P/T Fade

1. Double clicking center button to access main menu.
2. Tap the <Up/Down> button until “Options” is displayed.
3. Double clicking center button to access “Options”, Tap the <Up/Down> button to select “Reset P/T Fade”.
4. Double clicking center button to access “Reset P/T Fade”, The display will show “OFF”, Tap the <Up/Down> button to select “ON”.
5. Double click the center button to confirm or long press the center button to return to the main menu.

10.3.14. Frost(Progressive)

1. Double clicking center button to access main menu.
2. Tap the <Up/Down> button until “Options” is displayed.
3. Double clicking center button to access “Options”, Tap the <Up/Down> button to select “Frost(Progressive)”.

4. Double clicking center button to access “Frost(Progressive)”, The display will show “ON”, Tap the <Up/Down> button to select “OFF”.
5. Double click the center button to confirm or long press the center button to return to the main menu.

10.3.15. Trigger

DMX Value Disp.

With this function you can display the DMX 512 value of each channel. The display automatically shows the channel with a value changing.

1. Double clicking center button to access main menu.
2. Tap the <Up/Down> button until “Options” is displayed.
3. Double clicking center button to access “Options”, Tap the <Up/Down> button to select “Trigger”.
4. Double clicking center button to access “Trigger” menu, Tap the <Up/Down> button to select “DMX Value Disp”.
5. Double clicking center button to access “DMX Value Disp”, The display will show “PAN=.....”.
6. Double click the center button to confirm or long press the center button to return to the main menu.

Set To Slave

With this function, you can define the device as slave.

1. Double clicking center button to access main menu.
2. Tap the <Up/Down> button until “Options” is displayed.
3. Double clicking center button to access “Options”, Tap the <Up/Down> button to select “Trigger”.
4. Double clicking center button to access “Trigger” menu, Tap the <Up/Down> button to select “Set To Slave”.
5. Double clicking center button to access “Set To Slave”, The display will show “Slave1”, “Slave2”, “Slave3”.
6. Double click the center button to confirm or long press the center button to return to the main menu.

Auto Program

With this function, you can run the internal program. You can select the desired program under “**Select program**”. You can set the number of steps under “**Edit program**” . You can edit the individual scenes under “**Edit scenes**”. With this function, you can run the individual scenes either automatically, i.e. with the adjusted Step-Time.

1. Double clicking center button to access main menu.
2. Tap the <Up/Down> button until “Options” is displayed.
3. Double clicking center button to access “Options”, Tap the <Up/Down> button to select “Trigger”.
4. Double clicking center button to access “Trigger” menu, Tap the <Up/Down> button to select “Auto Program”.
5. Double clicking center button to access “Auto Program”, The display will show “Master”, “Alone”.
6. Double click the center button to confirm or long press the center button to return to the main menu.

10.3.16. Reset Default

With this function, you can select restore factory set for ON or OFF, the default is OFF.

1. Double clicking center button to access main menu.

2. Tap the <Up/Down> button until “Options” is displayed.
3. Double clicking center button to access “Options”, Tap the <Up/Down> button to select “Reset Default”.
4. Double clicking center button to access “Reset Default” menu, The display will show “OFF”, Tap the <Up/Down> button to select “ON”.
5. Double click the center button to confirm or long press the center button to return to the main menu.

10.3.17. Reset User

Address

1. Double clicking center button to access main menu.
2. Tap the <Up/Down> button until “Options” is displayed.
3. Double clicking center button to access “Options”, Tap the <Up/Down> button to select “Reset User”.
4. Double clicking center button to access “Reset User” menu, Tap the <Up/Down> button to select “Address”.
5. Double clicking center button to access “Address”, The display will show “DMX Address: 001-XXX”、“Decimal Universe: XXXXX”、“Net: XX”、“Sub-Net: X”、“Universe: X”..
6. Double click the center button to confirm or long press the center button to return to the main menu.

Mode

1. Double clicking center button to access main menu.
2. Tap the <Up/Down> button until “Options” is displayed.
3. Double clicking center button to access “Options”, Tap the <Up/Down> button to select “Reset User”.
4. Double clicking center button to access “Reset User” menu, Tap the <Up/Down> button to select “Mode”.
5. Double clicking center button to access “Mode”, The display will show “Extend Mode”. Tap the <Up/Down> button to select “User Mode A”, “User Mode B” and “User Mode C”.
6. Double click the center button to confirm or long press the center button to return to the main menu.

Fans Speed

1. Double clicking center button to access main menu.
2. Tap the <Up/Down> button until “Options” is displayed.
3. Double clicking center button to access “Options”, Tap the <Up/Down> button to select “Reset User”.
4. Double clicking center button to access “Reset User” menu, Tap the <Up/Down> button to select “Fans Speed”.
5. Double clicking center button to access “Fans Speed”, The display will show “Auto”. Tap the <Up/Down> button to select “Stage”, “Silence”, “Super Silence”.
6. Double click the center button to confirm or long press the center button to return to the main menu.

Constant Fans

1. Double clicking center button to access main menu.
2. Tap the <Up/Down> button until “Options” is displayed.
3. Double clicking center button to access “Options”, Tap the <Up/Down> button to select “Reset User”.

4. Double clicking center button to access “Reset User” menu, Tap the <Up/Down> button to select “Constant Fans”.
5. Double clicking center button to access “Constant Fans”, The display will show “OFF”. Tap the <Up/Down> button to select “ON”.
6. Double click the center button to confirm or long press the center button to return to the main menu.

10.4 Info

10.4.1. Time Info.

Current Time

With this function, you can display the temporary running time of the device from the last power on. The display shows “XXXX”, “XXXX” stands for the number of hours. The counter is reset after turning the device off.

1. Double clicking center button to access main menu.
2. Tap the <Up/Down> button until “Info” is displayed.
3. Double clicking center button to access “Info”, Tap the <Up/Down> button to select “Time Info.”.
4. Double clicking center button to access “Time Info.”, Tap the <Up/Down> button to select “Current Time”.
5. Double clicking center button to access “Current Time”, The display will show “XXXX (Hours)”.
6. Double click the center button to confirm or long press the center button to return to the main menu.

Ttl Life Hrs

With this function, you can display the running time of the device. The display shows “XXXX”, “XXXX” stands for the number of hours.

1. Double clicking center button to access main menu.
2. Tap the <Up/Down> button until “Info” is displayed.
3. Double clicking center button to access “Info”, Tap the <Up/Down> button to select “Time Info.”.
4. Double clicking center button to access “Time Info.”, Tap the <Up/Down> button to select “Ttl Life Hrs”.
5. Double clicking center button to access “Ttl Life Hrs”, The display will show “XXXX (Hours)”.
6. Double click the center button to confirm or long press the center button to return to the main menu.

Last Run Hrs

With this function, you can display last the running time of the device. The display shows “XXXX”, “XXXX” stands for the number of hours.

1. Double clicking center button to access main menu.
2. Tap the <Up/Down> button until “Info” is displayed.
3. Double clicking center button to access “Info”, Tap the <Up/Down> button to select “Time Info.”.
4. Double clicking center button to access “Time Info.”, Tap the <Up/Down> button to select “Last Run Hrs”.
5. Double clicking center button to access “Last Run Hrs”, The display will show “XXXX (Hours)”.
6. Double click the center button to confirm or long press the center button to return to the main menu.

LED Hours

With this function, you can display the time of LED. The display shows “XXXX”, “XXXX” stands for the time of LED.

1. Double clicking center button to access main menu.
2. Tap the <Up/Down> button until “Info” is displayed.
3. Double clicking center button to access “Info”, Tap the <Up/Down> button to select “Time Info.”.
4. Double clicking center button to access “Time Info.”, Tap the <Up/Down> button to select “LED Hours”.
5. Double clicking center button to access “LED Hours”, The display will show “XXXX (Hours)”.
6. Double click the center button to confirm or long press the center button to return to the main menu.

Timer PIN

With this function, you can display the timer password.

1. Double clicking center button to access main menu.
2. Tap the <Up/Down> button until “Info” is displayed.
3. Double clicking center button to access “Info”, Tap the <Up/Down> button to select “Time Info.”.
4. Double clicking center button to access “Time Info.”, Tap the <Up/Down> button to select “Timer PIN”.
5. Double clicking center button to access “Timer PIN”, The display will show “Password=038”.
6. Double click the center button to confirm or long press the center button to return to the main menu.

Clr Last Run

With this function, you can clear last run time of the fixture. The display shows “ON” or “OFF”, Press “Enter” to confirm.

1. Double clicking center button to access main menu.
2. Tap the <Up/Down> button until “Info” is displayed.
3. Double clicking center button to access “Info”, Tap the <Up/Down> button to select “Time Info.”.
4. Double clicking center button to access “Time Info.”, Tap the <Up/Down> button to select “Clear Last Run”.
5. Double clicking center button to access “Clear Last Run”, The display will show “OFF”, Tap the <Up/Down> button to select “ON”.
6. Double click the center button to confirm or long press the center button to return to the main menu.

10.4.2. Temp.Info

With this function you can display the temperature on the display board of the base (near CMY-filter) in Celsius.

1. Double clicking center button to access main menu.
2. Tap the <Up/Down> button until “Info” is displayed.
3. Double clicking center button to access “Info”, Tap the <Up/Down> button to select “Temp Info”.
4. Double clicking center button to access “Time Info.”, The display will show “XXX °C/ °F”.
5. Double click the center button to confirm or long press the center button to return to

the main menu.

10.4.3. Humidity

1. Double clicking center button to access main menu.
2. Tap the <Up/Down> button until “Info” is displayed.
3. Double clicking center button to access “Info”, Tap the <Up/Down> button to select “Humidity”.
4. Double clicking center button to access “Humidity”, The display will show “x%”.
5. Double click the center button to confirm or long press the center button to return to the main menu.

10.4.4. Encoder Info

1. Double clicking center button to access main menu.
2. Tap the <Up/Down> button until “Info” is displayed.
3. Double clicking center button to access “Info”, Tap the <Up/Down> button to select “Encoder Info”.
4. Double clicking center button to access “Encoder Info”, The display will show “xxx”.
5. Double click the center button to confirm or long press the center button to return to the main menu.

10.4.5. Fan Info.

With this function, you can display the software version of the device.

1. Double clicking center button to access main menu.
2. Tap the <Up/Down> button until “Info” is displayed.
3. Double clicking center button to access “Info”, Tap the <Up/Down> button to select “Fan Info.”.
4. Double clicking center button to access “Fan Info.”, The display will show “xxxxRPM”.
5. Double click the center button to confirm or long press the center button to return to the main menu.

10.4.6. LED Type

1. Double clicking center button to access main menu.
2. Tap the <Up/Down> button until “Info” is displayed.
3. Double clicking center button to access “Info”, Tap the <Up/Down> button to select “LED Type”.
4. Double clicking center button to access “LED Type”, The display will show “xxx”.
5. Double click the center button to confirm or long press the center button to return to the main menu.

10.4.7. Software Ver

With this function, you can display the software version of the device.

1. Double clicking center button to access main menu.
2. Tap the <Up/Down> button until “Info” is displayed.
3. Double clicking center button to access “Info”, Tap the <Up/Down> button to select “Software Ver”.
4. Double clicking center button to access “Software Ver”, The display will show “Ver x.x.x”.
5. Double click the center button to confirm or long press the center button to return to the main menu.

10.4.8. RTC

With this function, you can display the system time of the device.

1. Double clicking center button to access main menu.

2. Tap the <Up/Down> button until “Info” is displayed.
3. Double clicking center button to access “Info”, Tap the <Up/Down> button to select “RTC”.
4. Double clicking center button to access “RTC”, The display will show “xxx”.
5. Double click the center button to confirm or long press the center button to return to the main menu.

10.4.9. Signal Quality

1. Double clicking center button to access main menu.
2. Tap the <Up/Down> button until “Info” is displayed.
3. Double clicking center button to access “Info”, Tap the <Up/Down> button to select “Signal Quality”.
4. Double clicking center button to access “Signal Quality”, The display will show “xxx”.
5. Double click the center button to confirm or long press the center button to return to the main menu.

10.4.10. Network

1. Double clicking center button to access main menu.
2. Tap the <Up/Down> button until “Info” is displayed.
3. Double clicking center button to access “Info”, Tap the <Up/Down> button to select “Network”.
4. Double clicking center button to access “Network”, The display will show “IP” , Turn the center button to select “Mask”, “Mac”.
5. Double click the center button to confirm or long press the center button to return to the main menu.

10.4.11. Error Info

1. Double clicking center button to access main menu.
2. Tap the <Up/Down> button until “Info” is displayed.
3. Double clicking center button to access “Info”, Tap the <Up/Down> button to select “Error Info”.
4. Double clicking center button to access “Error Info”, The display will show “Error Record 1” , “.....”, “Error Record 10”.
5. Double click the center button to confirm or long press the center button to return to the main menu.

10.4.12. SN

1. Double clicking center button to access main menu.
2. Tap the <Up/Down> button until “Info” is displayed.
3. Double clicking center button to access “Info”, Tap the <Up/Down> button to select “SN”.
4. Double clicking center button to access “SN”, The display will show “xxxxxx”.
5. Double click the center button to confirm or long press the center button to return to the main menu.

10.5 Test

10.5.1. Home

With this function you can reset the device via the Control Board. You can select the different reset functions by turning the encoder.

1. Double clicking center button to access main menu.
2. Tap the <Up/Down> button until “Test” is displayed.
3. Double clicking center button to access “Test”, Tap the <Up/Down> button to select

“Home”.

4. Double clicking center button to access “Home”, The display will show “All” , Tap the <Up/Down> button to select “All”, “Pan&Tilt”, “Color”, “Gobo”, “Other”.
5. Double click the center button to confirm or long press the center button to return to the main menu.

10.5.2. Test Channel

With this function you can test each channel’s function to ensure correct operation.

1. Double clicking center button to access main menu.
2. Tap the <Up/Down> button until “Test” is displayed.
3. Double clicking center button to access “Test”, Tap the <Up/Down> button to select “Test Channel”.
4. Double clicking center button to access “Test Channel”, The display will show “Pan”, Tap the <Up/Down> button to select other channel.
5. Double click the center button to confirm or long press the center button to return to the main menu.

10.5.3. Manual Control

When set to Manual Mode, fixture will be back to factory settings. If want to adjust brightness, can adjust by shutter and dimming channel, channel value is 0-255. Other functions can be set according to user's real need.

1. Double clicking center button to access main menu.
2. Tap the <Up/Down> button until “Test” is displayed.
3. Double clicking center button to access “Test”, Tap the <Up/Down> button to select “Manual control”.
4. Double clicking center button to access “Manual control”, The display will show “PAN=XXX”.
5. Double click the center button to confirm or long press the center button to return to the main menu.

10.5.4. Calibration

With this function, you can calibrate and adjust the effect wheels to their correct positions. The password of calibrate values is 050.

1. Double clicking center button to access main menu.
2. Tap the <Up/Down> button until “Test” is displayed.
3. Double clicking center button to access “Test”, Tap the <Up/Down> button to select “Calibration”.
4. Double clicking center button to access “Calibration”, The display will show “Password=050”.
5. Double click the center button to confirm or long press the center button to return to the main menu.

10.5.5. Magn Auto Cal

1. Double clicking center button to access main menu.
2. Tap the <Up/Down> button until “Test” is displayed.
3. Double clicking center button to access “Test”, Tap the <Up/Down> button to select “Magn Auto Cal”.
4. Double clicking center button to access “Magn Auto Cal”, The display will show “Password=050”.
5. Double click the center button to confirm or long press the center button to return to the main menu.

10.5.6. Magn P/T 50%

1. Double clicking center button to access main menu.
2. Tap the <Up/Down> button until “Test” is displayed.
3. Double clicking center button to access “Test”, Tap the <Up/Down> button to select “Magn P/T 50%”.
4. Double clicking center button to access “Magn P/T 50%”, The display will show “Password=050”.
5. Double click the center button to confirm or long press the center button to return to the main menu.

10.5.7. Gobo Replace

1. Double clicking center button to access main menu.
2. Tap the <Up/Down> button until “Test” is displayed.
3. Double clicking center button to access “Test”, Tap the <Up/Down> button to select “Gobo Replace”.
4. Double clicking center button to access “Gobo Replace”, The display will show “Gobo Wheel 1”, “Gobo Wheel 2”.
5. Double click the center button to confirm or long press the center button to return to the main menu.

10.6 Preset

1. Double clicking center button to access main menu.
2. Tap the <Up/Down> button until “Preset” is displayed.
3. Double clicking center button to access “Preset”, Tap the <Up/Down> button to select “Select prog.”, “Edit prog.”, “Edit Scenes”, “Scenes Input”.
4. Double click the center button to confirm or long press the center button to return to the main menu.

Run the auto program: A master fixture can output to three different program signals to the slave fixture to operate. It means the host will send cyclically in the following orders (The host will keep operating the program of Part 1) Then the slave fixture will make the selectively receiving according to its own set.

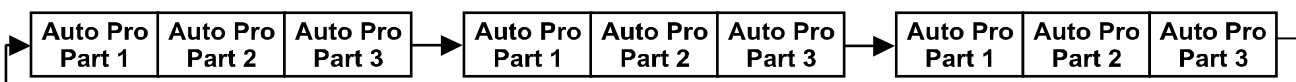

1. If the slave fixture chooses Run For Slave 1 from the menu of 1-3, then it will receive the part 1's automatic program from link, in the same way, when the slave fixture chooses Run For Slave 2, then it will receive the part 2's automatic program from link.
2. Enter the menu of 1-3 Function Mode---Set To Slave, Here to set machine operate which part of the program during the host-slave connection
3. Enter the menu of 1-4, 1-5 Function Mode---Set To Master
4. Enter the menu of 8-1 Edit Program---Auto Program Part1. The host outputs three groups driven program---Part1, Part2, Part3(Part1 program runs the same effect as the host)
5. Enter the menu of 8-2 Edit Program---Edit Program. Edit the program's connection, connect the scene in order
6. The editor of the scene, there are as many as 250 scenario editors, and every scene can have a program connection of 10.

Note:

Part 2, Part 3 repeat in accordance with the Part1's repeat. For example: When Part 1 uses Program 2, Part 2 uses Program 4, Part 3 uses Program 6, Assume: Program

2 includes scene of 10, 11, 12, 13; Program 4 includes scene of 8, 9, 10; Program 6 includes scene of 12, 13, 14, 15; Then it will run as below.

Example:

Part 1:

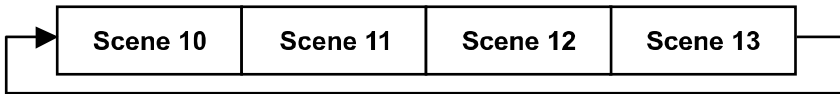

Part 2:

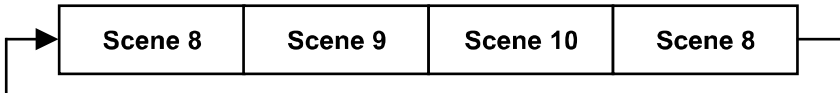

Part 3:

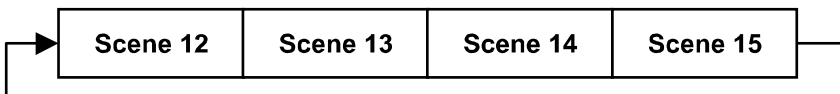

11. NFC

When the fixture is powered on, you can use a NFC smartphone installed with the Ayrton NFC App to scan the NFC tag area of the fixture to read some of the information or settings inside the display menu, such as product name, software version, UID, DMX Start Address, Universe, User Mode, Options, Information, etc. You can also change some of the settings and push to write inside the fixture menu.

When the fixture is not powered on, you can still use the App to read the NFC info and write the settings into the NFC tag, the written data will be automatically synchronized into the fixture menu at next time the fixture is powered on.

NOTE:

- Before using, make sure there is NFC function on your smartphone and it is activated, Download and install the Ayrton NFC App;
- The NFC tag on the fixture is right under the LCD window;
- The NFC reader area vary on different smartphones, identify the correct area on your smartphone before scanning the NFC tag on the fixture;
- When scanning, make sure the NFC reader area of your smartphone close enough to the LCD window and hold still the smartphone for 3 seconds until reading successfully.

11.1 How to use NFC

First install Ayrton NFC App into your mobile phone and enable NFC function of your mobile.

- 1) Open the Ayrton NFC App (as shown in Figure 1), tap the button to activate NFC scan (Figure 2), place the NFC scan area of your mobile phone close to the NFC tag area of the fixture, it will show the setting and configuration page after reading successfully (Figure 3). If the reading fails, it can be reread, or the device can be powered on again (Figure 4).

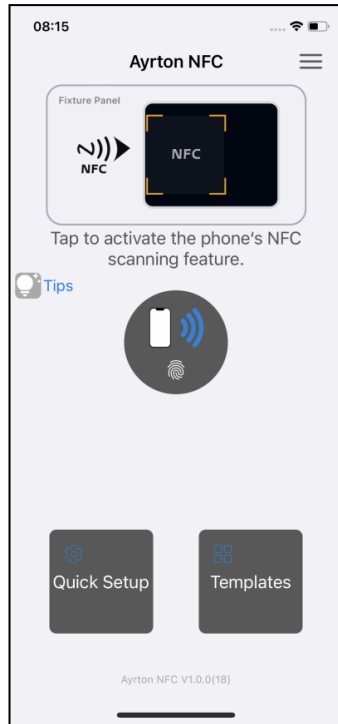

Figure 1

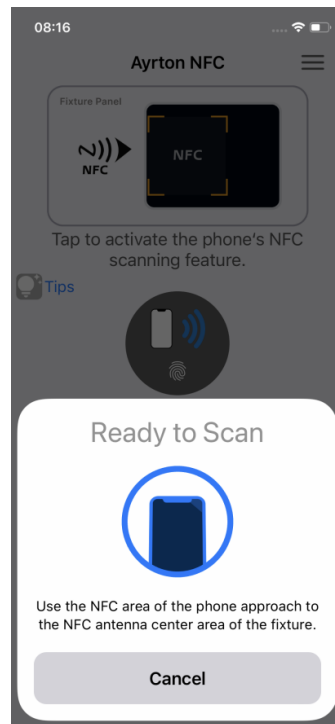

Figure 2

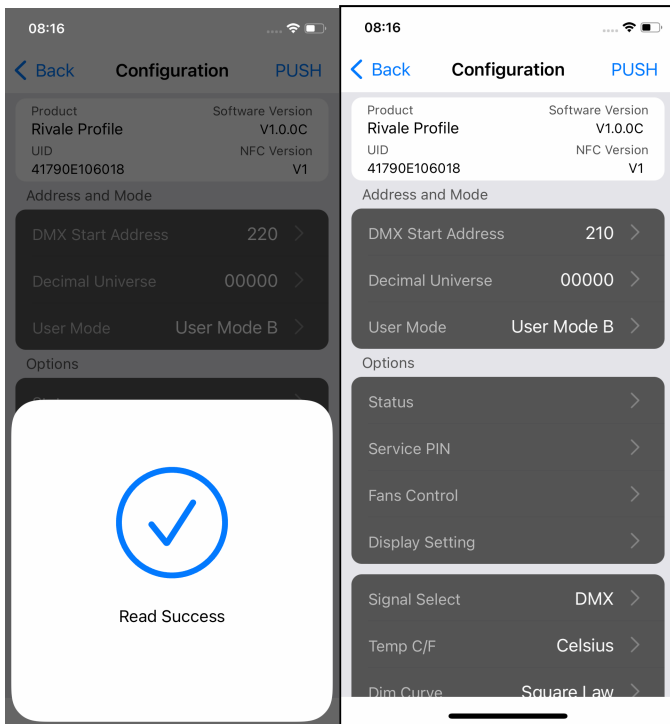

Figure 3

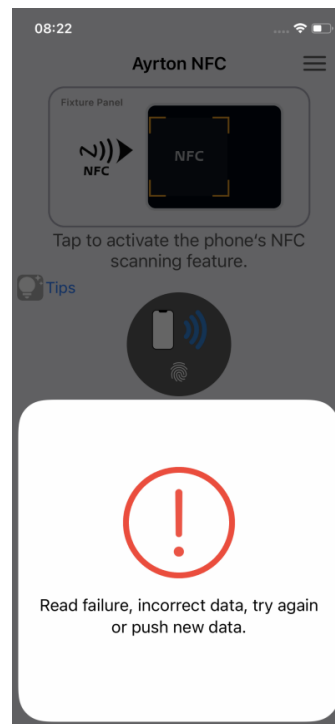

Figure 4

2) Change the device parameters such DMX address or User Mode or others (Figure 5,6):

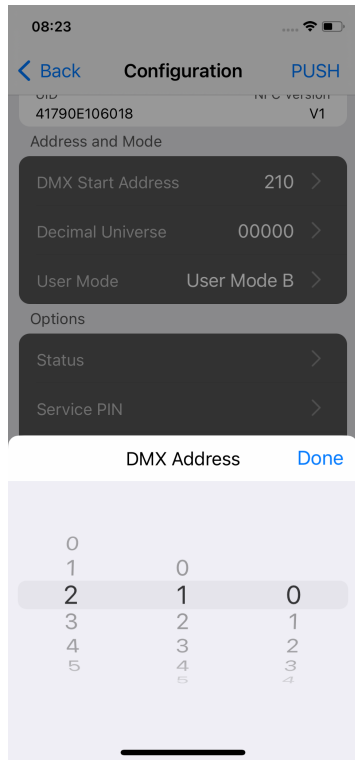

Figure 5

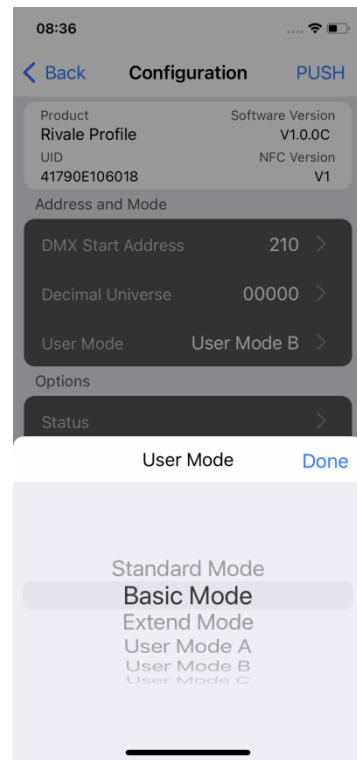

Figure 6

- 3) Tap 'PUSH' on the upper right corner (Figure 7,8) and place the NFC scan area of your mobile phone close to the NFC tag area of the fixture to write into the NFC tag (Figure 9).

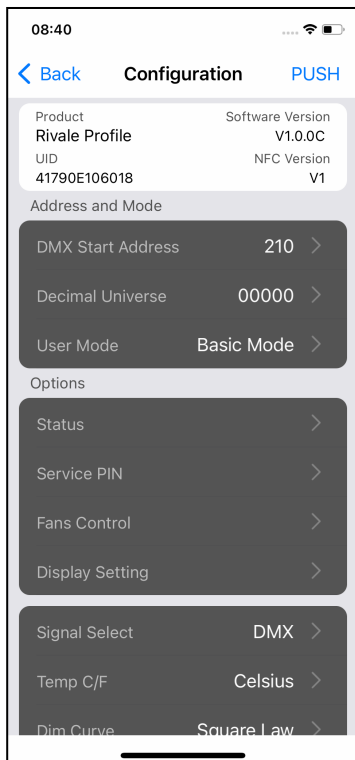

Figure 7

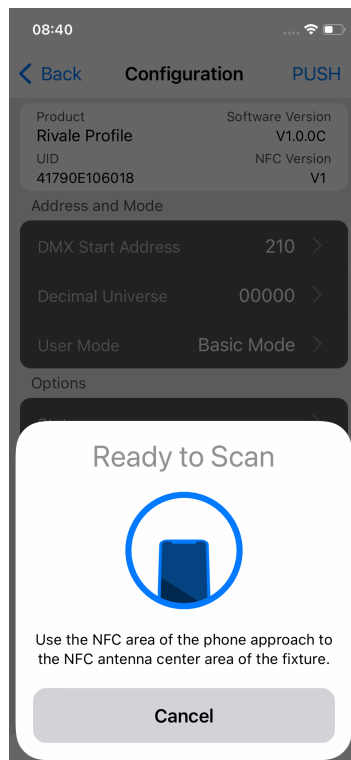

Figure 8

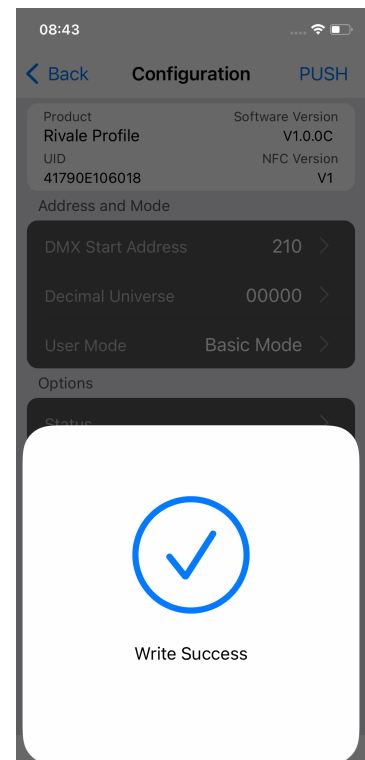

Figure 9

- 4) Quick Setup menu:
In the home page, tap the "Quick Setup" button to show the quick setup parameters (Figure

10) and tap the upper right corner button to view the quick setting options (Figure 11): “PUSH” to write the NFC settings (Figure 12), “EDIT” to add or delete the setting menus into the “Quick Setup” list (Figure 13).

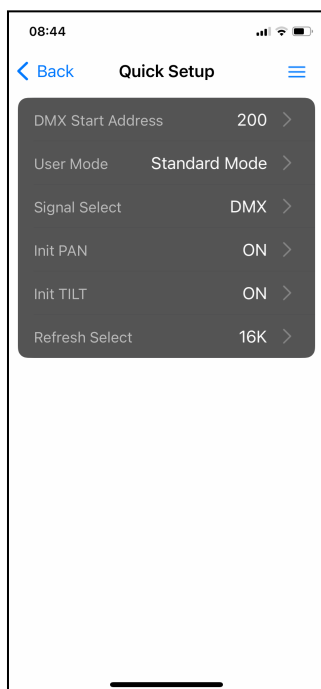

Figure 10

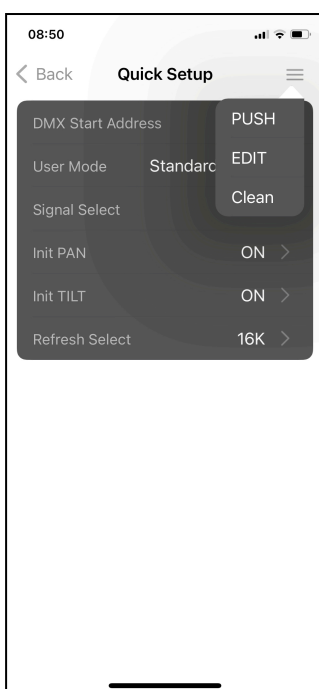

Figure 11

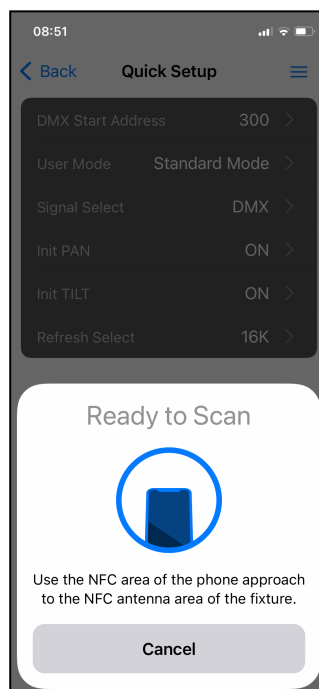

Figure 12

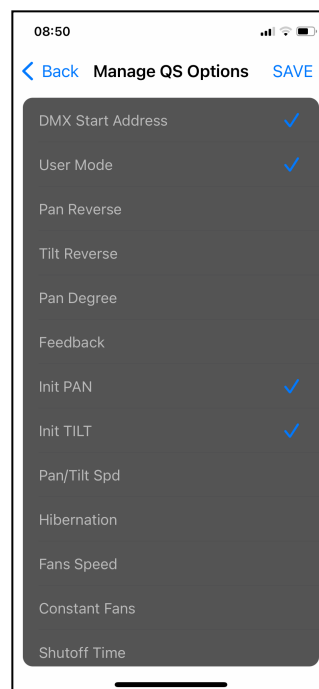

Figure 13

5) Templates menu

Create a fixture parameter template and set it to the corresponding fixture model
 Tap to enter the Templates list page (Figure 14), tap the upper right corner to add a new template for your fixture model (Figure 15), change the Template name and parameter settings and tap "ADD" to add into the Template list, as shown in Figure 16

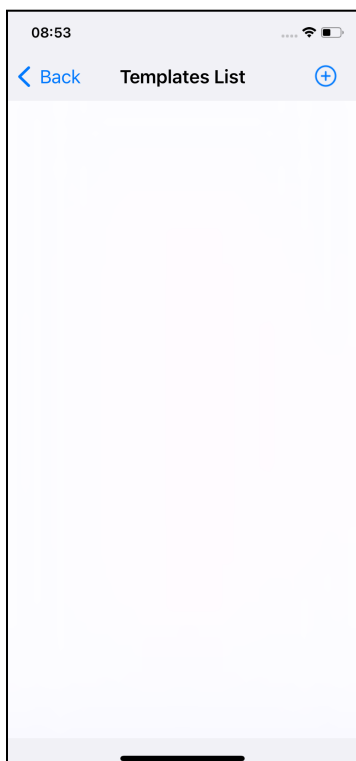

Figure 14

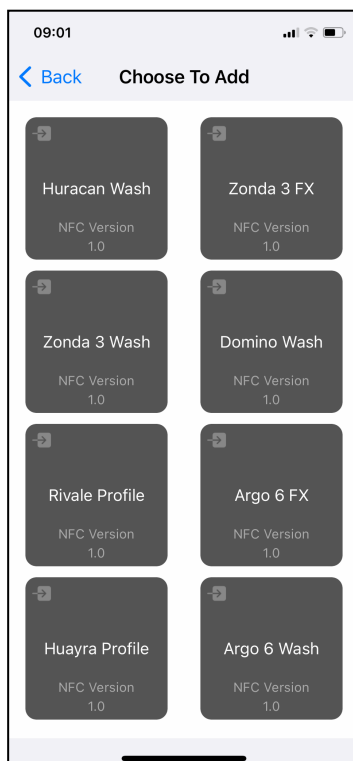

Figure 15

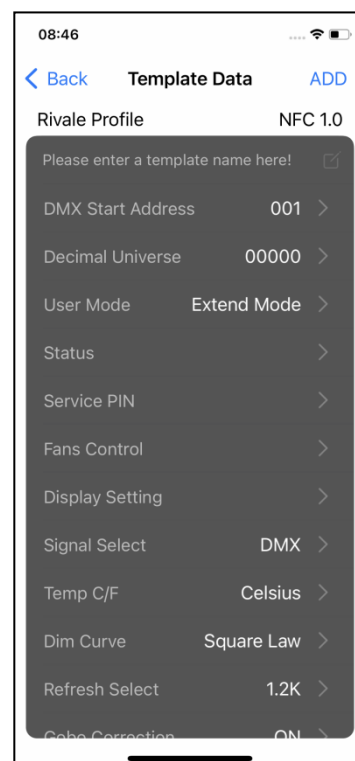

Figure 16

Pressing the desired template to activate the options (Figure 17,18), tap "PUSH" to write into the NFC tag of the fixture, as shown in Figure 19.

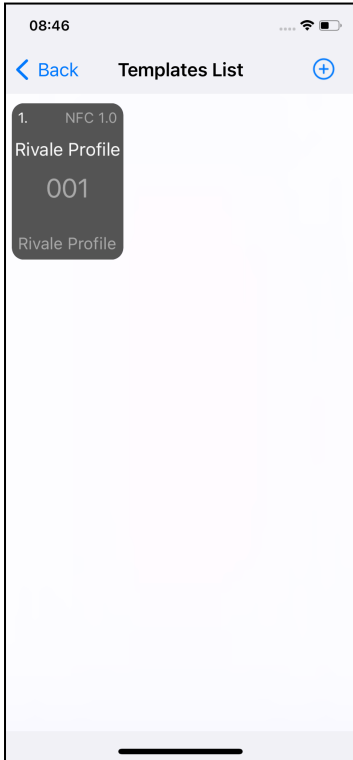

Figure 17

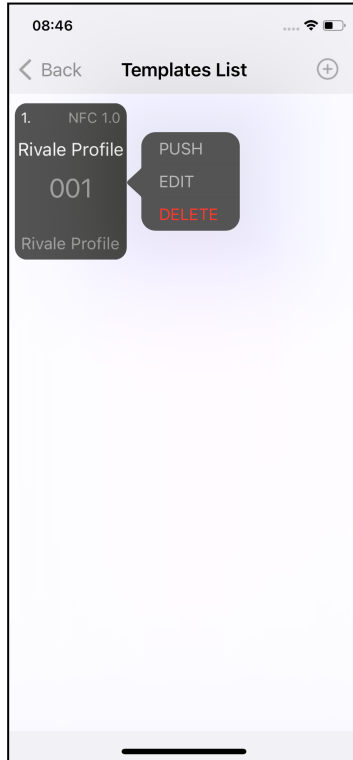

Figure 18

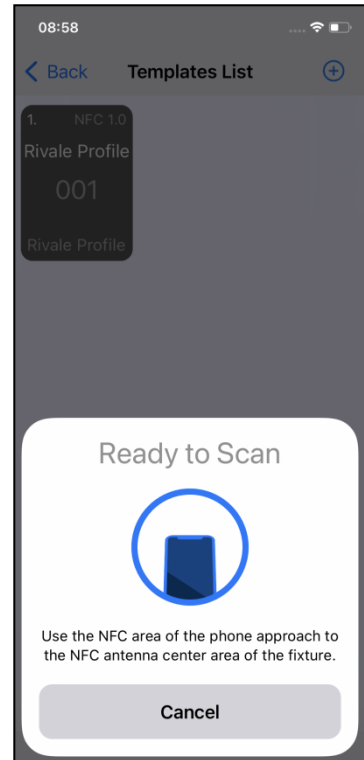

Figure 19

12. DMX PROTOCOL

DMX channel's functions and their values (65DMX channels):		
Mode/Channel	Value	Function
Ex		
1		<u>PAN Movement 8bit :</u>
	0-255	Pan Movement
2		<u>Pan Fine 16bit</u>
	0-255	Fine control of Pan movement
3		<u>TILT Movement 8bit :</u>
	0-255	Tilt Movement
4		<u>Tilt Fine 16bit</u>
	0-255	Fine control of Tilt movement
5		<u>Speed Pan/Tilt movement:</u>
	0-225	max to min speed
	226-235	blackout by movement
	236-245	blackout by all wheel changing
6	246-255	no function
		<u>Pan Motor continuous rotation</u>
	0-63	stop rotation by spinout

	64-127	stop rotation by shortcut
	128-189	Forwards Pan rotation from fast to slow
	190-193	No rotation
	194-255	Backwards Pan rotation from slow to fast
7		Tilt Motor continuous rotation
	0-63	stop rotation by spinout
	64-127	stop rotation by shortcut
	128-189	Forwards Tilt rotation from fast to slow
	190-193	No rotation
	194-255	Backwards Tilt rotation from slow to fast
8		<u>Shutter, strobe:</u>
	0-10	Shutter closed
	11-20	No function (shutter open)
	21-117	Strobe effect slow to fast
	118-126	No function (shutter open)
	127-180	Pulse-effect in sequences
	181-191	No function (shutter open)
	192-245	Random strobe effect slow to fast
246-255	No function (shutter open)	
9		<u>Dimmer intensity:</u>
	0-255	Intensity 0 to 100%
10		<u>Fine Dimmer intensity:</u>
	0-255	Dimmer intensity fine
11		<u>Zoom :</u>
	0-255	Zoom adjustment from small to big
12		<u>Zoom Fine:</u>
	0-255	Zoom adjustment Fine
13		<u>Focus :</u>
	0-255	Continuous adjustment from near to far
14		<u>Focus Fine:</u>
	0-255	Continuous adjustment Fine
15		<u>Auto Focus :</u>
	0-50	Auto Focus Off
	51-100	5m
	101-150	7.5m
	151-200	10m
201-255	15m	
16		<u>AutoFocus Fine:</u>
	0-255	Continuous adjustment Fine
17		<u>Color Wheel:</u>
	0-3	Open / white

	4-7	Color 1
	8-11	Color 2
	12-15	Color 3
	16-19	Color 4
	20-23	Color 5
	24-27	Color 6
	28-31	Color 7
	32-127	Color indexing
	128-189	Forwards rainbow effect from fast to slow
	190-193	No rotation
	194-255	Backwards rainbow effect from slow to fast
18		<u>Color Wheel Fine:</u>
	0-255	Color Wheel colour change to any position Fine
19		<u>Cyan Color :</u>
	0-255	Cyan (0-white, 255-100% Cyan)
20		<u>Cyan Color Fine :</u>
	0-255	Cyan Fine
21		<u>Magenta Color :</u>
	0-255	Magenta (0-white, 255-100% magenta)
22		<u>Magenta Color Fine :</u>
	0-255	Magenta Fine
23		<u>Yellow Color :</u>
	0-255	Yellow (0-white, 255-100% Yellow)
24		<u>Yellow Color Fine :</u>
	0-255	Yellow Fine
25		<u>CTO Color :</u>
	0-255	CTO (0-white, 255-100% CTO)
26		<u>CTO Color Fine :</u>
	0-255	CTO Fine
27		<u>CTP Color :</u>
	0-255	CTP (0-white, 255-100% CTP)
28		<u>CTP Color Fine :</u>
	0-255	CTP Fine
29		Reserved
30		Reserved
31		Reserved
32		<u>Rotating gobos, cont. rotation 1:</u>
	0-9	Open
	10-19	Rot. gobo 1
	20-29	Rot. gobo 2
	30-39	Rot. gobo 3

	40-49	Rot. gobo 4
	50-59	Rot. gobo 5
	60-69	Rot. gobo 6
	70-77	Rot. Gobo 7
	78-93	Gobo 1 shake slow to fast
	94-109	Gobo 2 shake slow to fast
	110-125	Gobo 3 shake slow to fast
	126-141	Gobo 4 shake slow to fast
	142-157	Gobo 5 shake slow to fast
	158-173	Gobo 6 shake slow to fast
	174-189	Gobo 7 shake slow to fast
	190-221	Gobo wheel rotation forwards from fast to slow
	222-223	No rotation
	224-255	Gobo wheel rotation f backwards from slow to fast
33		<u>Rotating gobo index,rotating gobo rotation 1:</u>
	0-127	Gobo indexing
	128-189	Forwards gobo rotation from fast to slow
	190-193	No rotation
	194-255	Backwards gobo rotation from slow to fast
34		<u>Rotating gobo indexing Fine 1:</u>
	0-255	Fine indexing
35		<u>Fixed Gobo2 :</u>
	0-9	open
	10-19	Gobo 1
	20-29	Gobo 2
	30-39	Gobo 3
	40-49	Gobo 4
	50-59	Gobo 5
	60-69	Gobo 6
	70-79	Gobo 7
	80-89	Gobo 8
	90-99	Gobo 9
	100-109	Gobo 1 shake slow to fast
	110-119	Gobo 2 shake slow to fast
	120-129	Gobo 3 shake slow to fast
	130-139	Gobo 4 shake slow to fast
	140-149	Gobo 5 shake slow to fast
	150-159	Gobo 6 shake slow to fast
	160-169	Gobo 7 shake slow to fast
170-179	Gobo 8 shake slow to fast	
	180-189	Gobo 9 shake slow to fast

	190-221	Clock-wise scroll from fast to slow
	222-223	Reserved
	224-255	Counter clock-wise scroll from slow to fast
36		<u>Animation wheel:</u>
	0-7	No rotation
	8-127	Forwards rotation from fast to slow
	128-135	No rotation
	136-255	Backwards rotation from slow to fast
37		<u>Iris:</u>
	0-191	Max. diameter to Min.diameter
	192-223	Pulse closing fast to slow
	224-255	Pulse opening slow to fast
38		<u>Iris Fine:</u>
	0-255	Iris Fine
39		<u>Prism 1:</u>
	0-127	Open
	128-255	Prism 1
40		<u>Rotating prism index, rotating prism rotation 1</u>
	0-127	Prism indexing
	128-189	Forwards prism rotation from fast to slow
	190-193	No rotation
	194-255	Backwards prism rotation from slow to fast
41		<u>Rotating prism indexing Fine 1:</u>
	0-255	Fine indexing
42		<u>Prism 2:</u>
	0-127	Open
	128-255	Prism 2
43		<u>Rotating prism index, rotating prism rotation 2</u>
	0-127	Prism indexing
	128-189	Forwards prism rotation from fast to slow
	190-193	No rotation
	194-255	Backwards prism rotation from slow to fast
44		<u>Rotating prism indexing Fine 2:</u>
	0-255	Fine indexing
45		<u>Frost 1:</u>
	0-255	0-100%
46		<u>Frost 2:</u>
	0-255	0-100%
47		<u>Blade 1A :</u>
	0-255	Open to Close
48		<u>Blade 1A Fine :</u>

	0-255	Open to Close Fine
49		<u>Blade 1B :</u>
	0-255	Open to Close
50		<u>Blade 1B Fine :</u>
	0-255	Open to Close Fine
51		<u>Blade 2A :</u>
	0-255	Open to Close
52		<u>Blade 2A Fine :</u>
	0-255	Open to Close Fine
53		<u>Blade 2B :</u>
	0-255	Open to Close
54		<u>Blade 2B Fine :</u>
	0-255	Open to Close Fine
55		<u>Blade 3A :</u>
	0-255	Open to Close
56		<u>Blade 3A Fine :</u>
	0-255	Open to Close Fine
57		<u>Blade 3B :</u>
	0-255	Open to Close
58		<u>Blade 3B Fine :</u>
	0-255	Open to Close Fine
59		<u>Blade 4A :</u>
	0-255	Open to Close
60		<u>Blade 4A Fine :</u>
	0-255	Open to Close Fine
61		<u>Blade 4B :</u>
	0-255	Open to Close
62		<u>Blade 4B Fine :</u>
	0-255	Open to Close Fine
63		<u>All Blade Rotation :</u>
	0-255	All Blade Rotation
64		<u>All Blade Rotation Fine :</u>
	0-255	All Blade Rotation Fine
65		<u>Control, reset, internal programs:</u>
	0-4	unused
	5-9	Display Off
	10-14	Display On
	15-19	Display Invert Off
	20-24	Display Invert On
	25-26	Auto fan control mode
27-28	Stage fan control mode	

29-30	Silence fan control mode
31-32	Super Silence fan control mode
33-34	Constant Fans Off
35-36	Constant Fans On
37-44	unused
45-49	Square Law
50-54	Linear
55-58	1.2K
59-62	2.4K
63-66	16K
67-69	25K
70-74	Gobo correction Off
75-79	Gobo correction On
80-84	All motor reset
85-87	Scan motor reset
88-90	Colors motor reset
91-93	Gobo motor reset
94	unused
95	Reset P/T Fade Off
96	Reset P/T Fade On
97-99	Other motor reset
100-102	Frost Progressive Off
103-105	Frost Progressive On
106-108	CMY speed Fast
109-111	CMY speed Medium
112-114	CMY speed Slow
115-117	unused
118-120	unused
121-123	Sun Protection Off
124-126	Sun Protection On
127-129	Pan Reverse Off
130-132	Pan Reverse On
133-135	Tilt Reverse Off
136-138	Tilt Reverse On
139-141	Pan Degree 540°
142-144	Pan Degree 630°
145-147	Tilt Degree 540°
148-150	Tilt Degree 270°
151-153	Feedback Off
154-156	Feedback On
157-159	Init PAN Off

160-162	Init PAN On
163-165	Init TILT Off
166-168	Init TILT On
169-171	Prerig INIT Off
172-174	Prerig INIT On
175-177	Reset Mode (Fast)
178-180	Reset Mode (All Rot Gobos)
181-183	Pan/Tilt Spd Medium
184-186	Pan/Tilt Spd Fast
187-189	Pan/Tilt Spd Slow
190-192	unused
193-195	Zoom/Focus Spd Fast
196-198	Zoom/Focus Spd Medium
199-201	Zoom/Focus Spd Slow
202-204	Reset LED Fade Off
205-207	Reset LED Fade On
208-210	Defog Off
211-213	Defog Auto
214-216	Defog On
217-255	unused

13. ERROR MESSAGES

When you turn on the device, it will first perform a reset. The display may show “Err channel is XX” should there be problems with one or more functions. “XX” stands for channel 1, 2, 3, 4, 5, 6 etc whose sensor has encountered a problem. For example, when the display shows “Err channel is Pan movement”, it means there is an error on channel 1. If there are errors on channel 1, channel 3, channel 6 at the same time, you may see the error message, “Err channel is Pan movement”, “Err channel is Tilt movement” “Err channel is Shutter”, flash twice, and then the device will generate a second reset. If the error messages persist after performing a reset more than twice, the channels which have errors may not work properly however, all other functions can work as usual. Please contact your dealer or manufacturer for service. Self repair is not allowed.

PAN- movement Er

(PAN- yoke movement error) This message will appear after the reset of the fixture if the yoke’s magnetic-indexing circuit malfunction (Optical Sensor or Magnetic Sensor fails) or the stepper motor is defective (or its driving IC on the main PCB). The PAN-movement is not located in the default position after the reset.

TILT- movement Er

(TILT- head movement error) This message will appear after the reset of the fixture if the head’s magnetic-indexing circuit malfunctions ((Optical Sensor or Magnetic Sensor fails)) or the stepper motor is defective (or its driving IC on the main PCB). The TILT-movement is not located in the default position after the reset.

Zoom wheel Er

(Zoom wheel error) This message will appear after the reset of the fixture if the head's magnetic-indexing circuit malfunctions (Optical Sensor or Magnetic Sensor fails) or the stepper motor is defective (or its driving IC on the main PCB).The Zoom -movement is not located in the default position after the reset.

Focus wheel Er

(Focus wheel error) This message will appear after the reset of the fixture if the head's magnetic-indexing circuit malfunctions (Optical Sensor or Magnetic Sensor fails) or the stepper motor is defective (or its driving IC on the main PCB).The Focus -movement is not located in the default position after the reset.

Color wheel Er

(Color wheel- error) This message will appear after the reset of the fixture if the head's magnetic-indexing circuit malfunctions (sensor failed or magnet missing) or the stepper motor is defective (or its driving IC on the main PCB).The Color - movement is not located in the default position after the reset.

Cyan Color wheel Er

(Cyan Color wheel- error) This message will appear after the reset of the fixture if the head's magnetic-indexing circuit malfunctions (sensor failed or magnet missing) or the stepper motor is defective (or its driving IC on the main PCB).The CMY -movement is not located in the default position after the reset.

Magenta Color wheel Er

(Magenta Color wheel- error) This message will appear after the reset of the fixture if the head's magnetic-indexing circuit malfunctions (sensor failed or magnet missing) or the stepper motor is defective (or its driving IC on the main PCB).The CMY -movement is not located in the default position after the reset.

Yellow Color wheel Er

(Yellow Color wheel- error) This message will appear after the reset of the fixture if the head's magnetic-indexing circuit malfunctions (sensor failed or magnet missing) or the stepper motor is defective (or its driving IC on the main PCB).The CMY -movement is not located in the default position after the reset.

CTO Color wheel Er

(CTO Color wheel- error) This message will appear after the reset of the fixture if the head's magnetic-indexing circuit malfunctions (sensor failed or magnet missing) or the stepper motor is defective (or its driving IC on the main PCB).The CTO -movement is not located in the default position after the reset.

Rot_Gobo wheel Er

(Rot_Gobo1wheel - error) This message will appear after the reset of the fixture if the head's magnetic-indexing circuit malfunctions (sensor failed or magnet missing) or the stepper motor is defective (or its driving IC on the main PCB).The Rot_Gobo1 - movement is not located in the default position after the reset.

Fix_Gobo wheel Er

(Fix_Gobo wheel - error) This message will appear after the reset of the fixture if the head's magnetic-indexing circuit malfunctions (sensor failed or magnet missing) or the stepper motor is defective (or its driving IC on the main PCB).The Fix_Gobo - movement is not located in the default position after the reset.

Animation wheel Er

(Animation wheel - error) This message will appear after the reset of the fixture if the head's magnetic-indexing circuit malfunctions (sensor failed or magnet missing) or the stepper motor is defective (or its driving IC on the main PCB).The Animation - movement is not located in the default position after the reset.

Iris wheel Er

(Iris wheel - error) This message will appear after the reset of the fixture if the head's magnetic-indexing circuit malfunctions (sensor failed or magnet missing) or the stepper motor is defective (or its driving IC on the main PCB).The Iris - movement is not located in the default position after the reset.

Prism 1 wheelEr

(Prism 1 wheel- error) This message will appear after the reset of the fixture if the head's magnetic-indexing circuit malfunctions (sensor failed or magnet missing) or the stepper motor is defective (or its driving IC on the main PCB).The Prism 1 - movement is not located in the default position after the reset.

Prism 2 wheelEr

(Prism 2 wheel- error) This message will appear after the reset of the fixture if the head's magnetic-indexing circuit malfunctions (sensor failed or magnet missing) or the stepper motor is defective (or its driving IC on the main PCB).The Prism 2 - movement is not located in the default position after the reset.

Blade 1 wheelEr

(Blade 1 wheel- error) This message will appear after the reset of the fixture if the head's magnetic-indexing circuit malfunctions (sensor failed or magnet missing) or the stepper motor is defective (or its driving IC on the main PCB).The Blade 1 - movement is not located in the default position after the reset.

Blade 1_Rot wheel Er

(Blade 1_Rot wheel- error) This message will appear after the reset of the fixture if the head's magnetic-indexing circuit malfunctions (sensor failed or magnet missing) or the stepper motor is defective (or its driving IC on the main PCB).The Blade 1_Rot - movement is not located in the default position after the reset.

Blade 2 wheel Er

(Blade 2 wheel- error) This message will appear after the reset of the fixture if the head's magnetic-indexing circuit malfunctions (sensor failed or magnet missing) or the stepper motor is defective (or its driving IC on the main PCB).The Blade 2 - movement is not located in the default position after the reset.

Blade 2_Rot wheel Er

(Blade 2_Rot wheel- error) This message will appear after the reset of the fixture if the head's magnetic-indexing circuit malfunctions (sensor failed or magnet missing) or the stepper motor is defective (or its driving IC on the main PCB).The Blade 2_Rot - movement is not located in the default position after the reset.

Blade 3 wheel Er

(Blade 3 wheel- error) This message will appear after the reset of the fixture if the head's magnetic-indexing circuit malfunctions (sensor failed or magnet missing) or the stepper motor is defective (or its driving IC on the main PCB).The Blade 3 - movement is not located in the default position after the reset.

Blade 3_Rot wheel Er

(Blade 3_Rot wheel- error) This message will appear after the reset of the fixture if the head's

magnetic-indexing circuit malfunctions (sensor failed or magnet missing) or the stepper motor is defective (or its driving IC on the main PCB).The Blade 3_Rot - movement is not located in the default position after the reset.

Blade 4 wheel Er

(Blade 4 wheel- error) This message will appear after the reset of the fixture if the head’s magnetic-indexing circuit malfunctions (sensor failed or magnet missing) or the stepper motor is defective (or its driving IC on the main PCB).The Blade 4 - movement is not located in the default position after the reset.

Blade 4_Rot wheel Er

(Blade 4_Rot wheel- error) This message will appear after the reset of the fixture if the head’s magnetic-indexing circuit malfunctions (sensor failed or magnet missing) or the stepper motor is defective (or its driving IC on the main PCB).The Blade 4_Rot - movement is not located in the default position after the reset.

All_Blade_Rot wheel Er

(All_Blade_Rot wheel- error) This message will appear after the reset of the fixture if the head’s magnetic-indexing circuit malfunctions (sensor failed or magnet missing) or the stepper motor is defective (or its driving IC on the main PCB).The All_Blade_Rot - movement is not located in the default position after the reset.

Frost 1 wheel Er

(Frost 1 wheel - error) This message will appear after the reset of the fixture if the head’s magnetic-indexing circuit malfunctions (sensor failed or magnet missing) or the stepper motor is defective (or its driving IC on the main PCB).The Frost 1 - movement is not located in the default position after the reset.



Frost 2 wheel Er



(Frost 2 wheel - error) This message will appear after the reset of the fixture if the head’s magnetic-indexing circuit malfunctions (sensor failed or magnet missing) or the stepper motor is defective (or its driving IC on the main PCB).The Frost 2 - movement is not located in the default position after the reset.

Animation_Rot wheel Er

(Animation_Rot wheel- error) This message will appear after the reset of the fixture if the head’s magnetic-indexing circuit malfunctions (sensor failed or magnet missing) or the stepper motor is defective (or its driving IC on the main PCB).The Animation_Rot - movement is not located in the default position after the reset.

14. CLEANING AND MAINTENANCE

	<p style="text-align: center;">CAUTION!</p> <p>DISCONNECT FROM MAINS BEFORE STARTING MAINTENANCE OPERATION.</p>
	<p style="text-align: center;">WARNING!</p> <p>DO NOT PLACE THE FIXTURE WITH ITS LENS/GLASS FACING ANY PEOPLE WHILE DOING THE IP TEST!</p>
	<p style="text-align: center;">CAUTION!</p> <p>NEVER USE ALCOHOL OR SOLVENT TO CLEAN THE LENSES !</p>

	<p>CAUTION!</p> <p>ALWAYS RUN AN IP TEST USING THE AYRTON IP TEST KIT FOLLOWING ANY MAINTENANCE OPERATION! FAILURE TO COMPLY WITH THIS CLAUSE WILL VOID THE WARRANTY!</p> <p>THE OPERATOR MUST FOLLOW STRICTLY THE VACUUM AND PRESSURE SETTING VALUES AS BELOW, OR USE THE CORRESPONDING PRESET FIXTURE MENU TO RUN THE IP TEST. ANY OVERPRESSURE OPERATION MAY CAUSE ACCIDENTAL DAMAGE OR INJURY.</p>	 <p>AYRTON IP TEST KIT</p>
---	---	---

	Minimum value		Maximum value		Steady time (Hold time)
	Kpa	Psi	Kpa	Psi	
Vacuum	-30	-4.35	-35	5.08	10
Pressure	25	3.63	30	4.35	10

NOTE: When using external equipment to test air tightness, air can only be filled and extracted from the exhaust hole of the bottom base, not from the exhaust hole of the fixture head.

Once the covers removed and before set them back, check the cover gasket to avoid any leak due to gasket damage.

Cross tightening the die-casting covers HEX screws at the right torque value.

Use a **Torque Screwdriver set at 14Kgf.cm for metal cover or 7Kgf.cm for plastic cover.**

The following points have to be considered during inspection:

- 1) All screws for installing the devices or parts of the device have to be tightly connected and must not be corroded.
- 2) All external magnesium alloy covers screws must be used together with the plastic sleeves. If the plastic sleeve is damaged, it must be replaced with a new one.
- 3) Do not do maintenance or assembly for the external magnesium alloy cover in outdoor environment with rain or water on it. Before removing the screws, ensure that the surroundings of the screws are dry. After maintenance, before assembling the covers, ensure that the screws and screw holds are dry.
- 4) There must not be any deformations to the housing, lenses, rigging and installation points (ceiling, suspension, trussing).
- 5) Motorized parts must not show any signs of wear and must move smoothly without issue.
- 6) The power supply cables must not show any damage, material fatigue or sediment.

Checking and replacing the desiccant

The desiccant is used as humidity indication in the fixture. Dry desiccant is in blue color, if it is saturated with water, its color changes to light red. If the desiccant color changes to pink, the desiccant is losing efficacy, it must be replaced.

	<p>UNPUG THE FIXTURE FROM MAINS BEFORE CHECKING OR REPLACING DESICCANT!</p> <p>DO NOT CHECK OR REPLACE DESICCANT IN A DAMP ENVIRONMENT!</p>
---	---

Further instructions depending on the installation location and usage have to be adhered to by a qualified installer and any safety concerns have to be removed.

In order to ensure the fixture remains in good condition and does not fail prematurely thus extend the lifespan of the fixture, we suggest regular maintenance and cleaning, especially when the fixture being installed outdoors with the following conditions which may easily cause peeling or corrosion of the surface coating of the fixture:

- Use in coastal or high salinity areas.
- Use in areas contaminated with coal ash, oil fume, mineral dust, iron powder, or chemical substances, etc..
- Fixture surface accumulated with burnt tar, resin, insect dead body or its droppings, bird droppings, etc..
- Liquids such as benzene, gasoline or diesel was splashed onto the surface of the fixture.
- Residues of movable props such as colored powder, foam and sequins on the surface.

Notes for cleaning:

- Before cleaning the fixture, please ensure that the power connection of the fixture is disconnected and completely cooled. Use sponge or a soft cloths for surface cleaning.
- Do not use acidic, alkaline or abrasive detergents for cleaning.
- Do not use a hard brush to brush the covers directly.
- When using a high-pressure water gun for cleaning, please pay attention to the water pressure and spraying distance.
- Do not allow the high-pressure water gun to continuously wash the same area for long time, especially on the XLR connectors, display button, arm rotation areas, etc..
- If the fixture being used outdoors, cleaning and maintenance should be carried out at least every 3 months depending on the using conditions. This period may need to be shortened and need to be cleaned timely if the fixture being used in coastal or high salinity areas.
- During winter use, if using snow remover in the scene, please protect the fixture to avoid fixture surface being contaminated.
- During cleaning and maintenance, if slight coating damage is found on the die-casting cover's surface, then after cleaning is completed and surface is dried, repair for the surface treatment can be carried out by using hand spray paint. If the cover's damaged surface is severe, please contact your local dealer or ARYTON for replacement parts in a timely manner
- If obvious corrosion marks such as blistering or damage are found on the coating of the fixture's die-casting cover, please contact your local dealer or ARYTON for replacement parts for repair in a timely manner.

We recommend frequent cleaning of the device. Please use a moist, lint- free cloth. Never use alcohol or solvents.

Please refer to the instructions under "Installation instructions".

Should you need any spare parts, please order genuine parts from your local dealer.

All information is subject to change without prior notice.

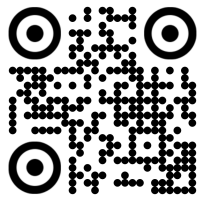

scan for more on
www.ayrton.eu



AYRTON
Digital Lighting

2 Rue de Vitruve - 91140 - Villebon-sur-Yvette - France